

HAL-Handbuch V2.5, 2018-10-21

Contents

I	HAL	1
1	HAL Introduction	2
1.1	HAL is based on traditional system design techniques	2
1.1.1	Part Selection	2
1.1.2	Interconnection Design	2
1.1.3	Implementation	3
1.1.4	Testing	3
1.1.5	Summary	3
1.2	HAL Concepts	4
1.3	HAL components	5
1.3.1	External Programs with HAL hooks	5
1.3.2	Internal Components	5
1.3.3	Hardware Drivers	6
1.3.4	Tools and Utilities	6
1.4	Timing Issues In HAL	6
2	Advanced HAL Tutorial	8
2.1	Introduction	8
2.1.1	Notation	8
2.1.2	Tab-completion	8
2.1.3	The RTAPI environment	8
2.2	A Simple Example	9
2.2.1	Loading a component	9
2.2.2	Examining the HAL	9
2.2.3	Making realtime code run	10
2.2.4	Changing Parameters	12
2.2.5	Saving the HAL configuration	12
2.2.6	Exiting halrun	13
2.2.7	Restoring the HAL configuration	13

2.2.8	Removing HAL from memory	13
2.3	Halmeter	13
2.4	Stepgen Example	15
2.4.1	Installing the components	15
2.4.2	Connecting pins with signals	16
2.4.3	Setting up realtime execution - threads and functions	17
2.4.4	Setting parameters	18
2.4.5	Run it!	19
2.5	Halscope	19
2.5.1	Hooking up the scope probes	21
2.5.2	Capturing our first waveforms	24
2.5.3	Vertical Adjustments	25
2.5.4	Triggering	26
2.5.5	Horizontal Adjustments	28
2.5.6	More Channels	29
2.5.7	More samples	30
3	General Reference	31
3.1	General Naming Conventions	31
3.2	Hardware Driver Naming Conventions	31
3.2.1	Pin/Parameter names	31
3.2.2	Function Names	32
4	Canonical Device Interfaces	34
4.1	Introduction	34
4.2	Digital Input	34
4.2.1	Pins	34
4.2.2	Parameters	34
4.2.3	Functions	34
4.3	Digital Output	34
4.3.1	Pins	35
4.3.2	Parameters	35
4.3.3	Functions	35
4.4	Analog Input	35
4.4.1	Pins	35
4.4.2	Parameters	35
4.4.3	Functions	35
4.5	Analog Output	35
4.5.1	Pins	35
4.5.2	Parameters	36
4.5.3	Functions	36

5	HAL Tools	37
5.1	Halcmd	37
5.2	Halmeter	37
5.3	Halscope	38
6	Basic HAL Tutorial	39
6.1	HAL Commands	39
6.1.1	loadrt	40
6.1.2	addf	40
6.1.3	loadusr	41
6.1.4	net	41
6.1.5	setp	42
6.1.6	sets	43
6.1.7	unlinkp	43
6.1.8	Obsolete Commands	43
6.1.8.1	linksp	43
6.1.8.2	linkps	44
6.1.8.3	newsig	44
6.2	HAL Data	44
6.2.1	Bit	44
6.2.2	Float	44
6.2.3	s32	44
6.2.4	u32	44
6.3	HAL Files	45
6.4	HAL Components	45
6.5	Logic Components	45
6.5.1	and2	45
6.5.2	not	46
6.5.3	or2	46
6.5.4	xor2	46
6.5.5	Logic Examples	47
6.6	Conversion Components	47
6.6.1	weighted_sum	47
7	Halshow	49
7.1	Starting Halshow	49
7.2	HAL Tree Area	49
7.3	HAL Show Area	51
7.4	HAL Watch Area	54

8 HAL Components	56
8.1 Commands and Userspace Components	56
8.2 Realtime Components List	57
8.2.1 Core LinuxCNC components	57
8.2.2 Logic and bitwise components	57
8.2.3 Arithmetic and float-components	58
8.2.4 Type conversion	59
8.2.5 Hardware drivers	60
8.2.6 Kinematics	60
8.2.7 Motor control	61
8.2.8 BLDC and 3-phase motor control	61
8.2.9 Other	62
8.3 HAL API calls	63
8.4 RTAPI calls	64
9 HAL Component Descriptions	66
9.1 Steppen	66
9.2 PWMgen	73
9.3 Encoder	74
9.4 PID	77
9.5 Simulated Encoder	79
9.6 Debounce	80
9.7 Siggen	80
9.8 lut5	81
10 Parallel Port Driver	83
10.1 Parport	83
10.1.1 Installing	83
10.1.2 Pins	84
10.1.3 Parameters	85
10.1.4 Functions	85
10.1.5 Common problems	85
10.1.6 Using DoubleStep	86
10.2 probe_parport	86
10.2.1 Installing	86
11 HAL Examples	87
11.1 Manual Toolchange	87
11.2 Compute Velocity	87
11.3 Soft Start	89
11.4 Stand Alone HAL	90

12 HAL User Interface	92
12.1 Introduction	92
12.2 Halui pin reference	92
13 Halui Examples	98
13.1 Remote Start	98
13.2 Pause & Resume	99
14 Comp HAL Component Generator	100
14.1 Introduction	100
14.2 Installing	100
14.3 Definitions	100
14.4 Instance creation	101
14.5 Implicit Parameters	101
14.6 Syntax	101
14.6.1 HAL functions	103
14.6.2 Options	103
14.6.3 License and Authorship	103
14.6.4 Per-instance data storage	104
14.6.5 Comments	104
14.7 Restrictions	104
14.8 Convenience Macros	105
14.9 Components with one function	105
14.10Component Personality	105
14.11Compiling	105
14.12Compiling realtime components outside the source tree	106
14.13Compiling userspace components outside the source tree	106
14.14Examples	106
14.14.1 constant	106
14.14.2 sincos	107
14.14.3 out8	107
14.14.4 hal_loop	108
14.14.5 arraydemo	108
14.14.6 rand	108
14.14.7 logic	109

15	Creating Userspace Python Components	110
15.1	Basic usage	110
15.2	Userspace components and delays	111
15.3	Create pins and parameters	111
15.3.1	Changing the prefix	111
15.4	Reading and writing pins and parameters	111
15.4.1	Driving output (HAL_OUT) pins	112
15.4.2	Driving bidirectional (HAL_IO) pins	112
15.5	Exiting	112
15.6	Project ideas	112
II	Hardware Drivers	113
16	AX5214H Driver	114
16.1	Installing	114
16.2	Pins	114
16.3	Parameters	114
16.4	Functions	115
17	GS2 VFD Driver	116
17.1	Command Line Options	116
17.2	Pins	116
17.3	Parameters	117
18	Mesa HostMot2 Driver	118
18.1	Introduction	118
18.2	Firmware Binaries	118
18.3	Installing Firmware	119
18.4	Loading HostMot2	119
18.5	Watchdog	119
18.5.1	Pins:	119
18.5.2	Parameters:	119
18.5.3	Functions:	119
18.6	HostMot2 Functions	120
18.7	Pinouts	120
18.8	PIN Files	121
18.9	Firmware	121
18.10	HAL Pins	121
18.11	Configurations	122
18.12	GPIO	124

18.12.1 Pins	124
18.12.2 Parameters	124
18.13 StepGen	125
18.13.1 Pins	125
18.13.2 Parameters	125
18.13.3 Output Parameters	126
18.14 PWMGen	126
18.14.1 Pins	126
18.14.2 Parameters	126
18.14.3 Output Parameters	127
18.15 Encoder	127
18.15.1 Pins	127
18.15.2 Parameters	128
18.16 5i25 Configuration	128
18.16.1 Firmware	128
18.16.2 Configuration	128
18.16.3 SSERIAL Configuration	129
18.16.4 7i77 Limits	129
18.17 Example Configurations	129
19 Motenc Driver	130
19.1 Pins	130
19.2 Parameters	131
19.3 Functions	131
20 Opto22 Driver	132
20.1 The Adapter Card	132
20.2 The Driver	132
20.3 Pins	132
20.4 Parameters	133
20.5 FUNCTIONS	133
20.6 Configuring I/O Ports	133
20.7 Pin Numbering	134
21 Pico Drivers	135
21.1 Command Line Options	135
21.2 Pins	136
21.3 Parameters	137
21.4 Functions	138

22 Pluto P Driver	139
22.1 General Info	139
22.1.1 Requirements	139
22.1.2 Connectors	139
22.1.3 Physical Pins	139
22.1.4 LED	140
22.1.5 Power	140
22.1.6 PC interface	140
22.1.7 Rebuilding the FPGA firmware	140
22.1.8 For more information	140
22.2 Pluto Servo	140
22.2.1 Pinout	141
22.2.2 Input latching and output updating	142
22.2.3 HAL Functions, Pins and Parameters	142
22.2.4 Compatible driver hardware	143
22.3 Pluto Step	143
22.3.1 Pinout	143
22.3.2 Input latching and output updating	144
22.3.3 Step Waveform Timings	144
22.3.4 HAL Functions, Pins and Parameters	145
23 Servo To Go Driver	146
23.1 Installing	146
23.2 Pins	146
23.3 Parameters	147
23.3.1 Functions	147
24 Legal Section	148
24.1 Copyright Terms	148
24.2 GNU Free Documentation License	148
25 Index	152

The LinuxCNC Team



This handbook is a work in progress. If you are able to help with writing, editing, or graphic preparation please contact any member of the writing team or join and send an email to emc-users@lists.sourceforge.net.

Copyright © 2000-2012 LinuxCNC.org

Permission is granted to copy, distribute and/or modify this document under the terms of the GNU Free Documentation License, Version 1.1 or any later version published by the Free Software Foundation; with no Invariant Sections, no Front-Cover Texts, and one Back-Cover Text: This LinuxCNC Handbook is the product of several authors writing for linuxCNC.org. As you find it to be of value in your work, we invite you to contribute to its revision and growth. A copy of the license is included in the section entitled GNU Free Documentation License. If you do not find the license you may order a copy from Free Software Foundation, Inc. 59 Temple Place, Suite 330 Boston, MA 02111-1307

LINUX® is the registered trademark of Linus Torvalds in the U.S. and other countries. The registered trademark Linux® is used pursuant to a sublicense from LMI, the exclusive licensee of Linus Torvalds, owner of the mark on a world-wide basis.

HINWEIS

Aufgrund der in jüngster Zeit zunehmend in das Interesse an anderen Übersetzungen, die EMC2 Team hat vor kurzem diese Bemühungen begonnen, eine zu liefern Deutsch-Übersetzung der EMC2 Dokumentation.

Wenn Sie möchten, einen Freiwilligen-Editor für die sein Deutsch-Übersetzung von EMC2, kontaktieren Sie uns bitte.

NOTICE

Because of a recent increase in interest in other translations, the EMC2 team has recently begun this effort to deliver a German Translation of the EMC2 documentation.

If you would like to be a volunteer editor for the German translation of EMC2, please contact us.

Part I

HAL

Chapter 1

HAL Introduction

HAL stands for Hardware Abstraction Layer. At the highest level, it is simply a way to allow a number of *building blocks* to be loaded and interconnected to assemble a complex system. The *Hardware* part is because HAL was originally designed to make it easier to configure LinuxCNC for a wide variety of hardware devices. Many of the building blocks are drivers for hardware devices. However, HAL can do more than just configure hardware drivers.

1.1 HAL is based on traditional system design techniques

HAL is based on the same principles that are used to design hardware circuits and systems, so it is useful to examine those principles first.

Any system (including a CNC machine), consists of interconnected components. For the CNC machine, those components might be the main controller, servo amps or stepper drives, motors, encoders, limit switches, pushbutton pendants, perhaps a VFD for the spindle drive, a PLC to run a toolchanger, etc. The machine builder must select, mount and wire these pieces together to make a complete system.

1.1.1 Part Selection

The machine builder does not need to worry about how each individual part works. He treats them as black boxes. During the design stage, he decides which parts he is going to use - steppers or servos, which brand of servo amp, what kind of limit switches and how many, etc. The integrator's decisions about which specific components to use is based on what that component does and the specifications supplied by the manufacturer of the device. The size of a motor and the load it must drive will affect the choice of amplifier needed to run it. The choice of amplifier may affect the kinds of feedback needed by the amp and the velocity or position signals that must be sent to the amp from a control.

In the HAL world, the integrator must decide what HAL components are needed. Usually every interface card will require a driver. Additional components may be needed for software generation of step pulses, PLC functionality, and a wide variety of other tasks.

1.1.2 Interconnection Design

The designer of a hardware system not only selects the parts, he also decides how those parts will be interconnected. Each black box has terminals, perhaps only two for a simple switch, or dozens for a servo drive or PLC. They need to be wired together. The motors connect to the servo amps, the limit switches connect to the controller, and so on. As the machine builder works on the design, he creates a large wiring diagram that shows how all the parts should be interconnected.

When using HAL, components are interconnected by signals. The designer must decide which signals are needed, and what they should connect.

1.1.3 Implementation

Once the wiring diagram is complete it is time to build the machine. The pieces need to be acquired and mounted, and then they are interconnected according to the wiring diagram. In a physical system, each interconnection is a piece of wire that needs to be cut and connected to the appropriate terminals.

HAL provides a number of tools to help *build* a HAL system. Some of the tools allow you to *connect* (or disconnect) a single *wire*. Other tools allow you to save a complete list of all the parts, wires, and other information about the system, so that it can be *rebuilt* with a single command.

1.1.4 Testing

Very few machines work right the first time. While testing, the builder may use a meter to see whether a limit switch is working or to measure the DC voltage going to a servo motor. He may hook up an oscilloscope to check the tuning of a drive, or to look for electrical noise. He may find a problem that requires the wiring diagram to be changed; perhaps a part needs to be connected differently or replaced with something completely different.

HAL provides the software equivalents of a voltmeter, oscilloscope, signal generator, and other tools needed for testing and tuning a system. The same commands used to build the system can be used to make changes as needed.

1.1.5 Summary

This document is aimed at people who already know how to do this kind of hardware system integration, but who do not know how to connect the hardware to LinuxCNC. See the [Remote Start Example](#) section in the HAL UI Examples documentation.

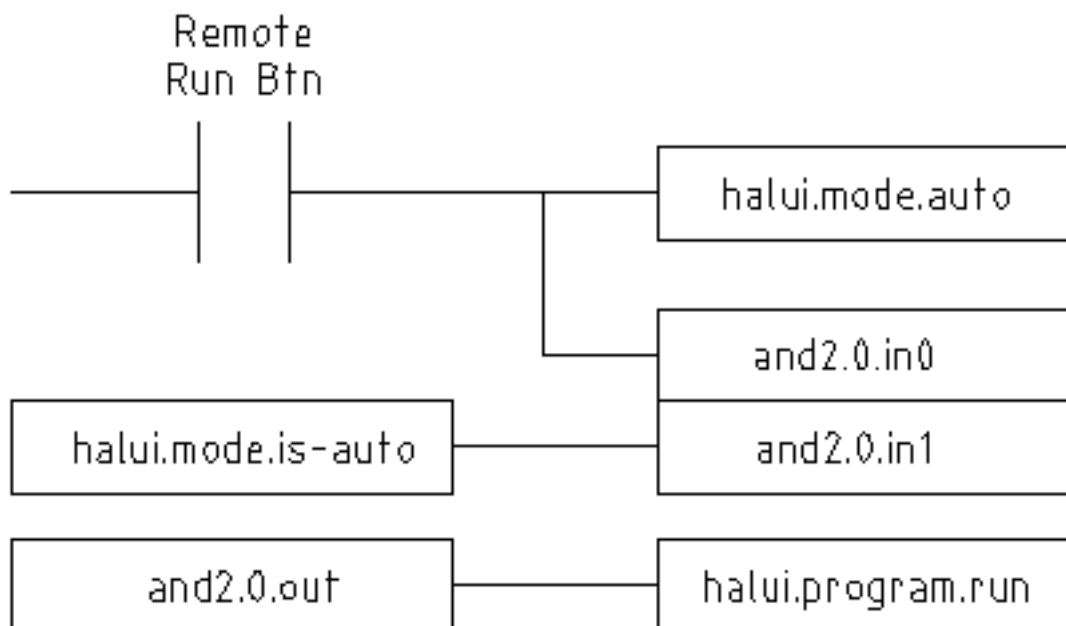

The traditional hardware design as described above ends at the edge of the main control. Outside the control are a bunch of relatively simple boxes, connected together to do whatever is needed. Inside, the control is a big mystery — one huge black box that we hope works.

HAL extends this traditional hardware design method to the inside of the big black box. It makes device drivers and even some internal parts of the controller into smaller black boxes that can be interconnected and even replaced just like the external hardware. It allows the *system wiring diagram* to show part of the internal controller, rather than just a big black box. And most importantly, it allows the integrator to test and modify the controller using the same methods he would use on the rest of the hardware.

Terms like motors, amps, and encoders are familiar to most machine integrators. When we talk about using extra flexible eight conductor shielded cable to connect an encoder to the servo input board in the computer, the reader immediately understands what it is and is led to the question, *what kinds of connectors will I need to make up each end*. The same sort of thinking is essential for the HAL but the specific train of thought may take a bit to get on track. Using HAL words may seem a bit strange at first, but the concept of working from one connection to the next is the same.

This idea of extending the wiring diagram to the inside of the controller is what HAL is all about. If you are comfortable with the idea of interconnecting hardware black boxes, you will probably have little trouble using HAL to interconnect software black boxes.

1.2 HAL Concepts

This section is a glossary that defines key HAL terms but it is a bit different than a traditional glossary because these terms are not arranged in alphabetical order. They are arranged by their relationship or flow in the HAL way of things.

Component

When we talked about hardware design, we referred to the individual pieces as *parts, building blocks, black boxes*, etc. The HAL equivalent is a *component* or *HAL component*. (This document uses *HAL component* when there is likely to be confusion with other kinds of components, but normally just uses *component*.) A HAL component is a piece of software with well-defined inputs, outputs, and behavior, that can be installed and interconnected as needed.

Parameter

Many hardware components have adjustments that are not connected to any other components but still need to be accessed. For example, servo amps often have trim pots to allow for tuning adjustments, and test points where a meter or scope can be attached to view the tuning results. HAL components also can have such items, which are referred to as *parameters*. There are two types of parameters: Input parameters are equivalent to trim pots - they are values that can be adjusted by the user, and remain fixed once they are set. Output parameters cannot be adjusted by the user - they are equivalent to test points that allow internal signals to be monitored.

Pin

Hardware components have terminals which are used to interconnect them. The HAL equivalent is a *pin* or *HAL pin*. (*HAL pin* is used when needed to avoid confusion.) All HAL pins are named, and the pin names are used when interconnecting them. HAL pins are software entities that exist only inside the computer.

Physical_Pin

Many I/O devices have real physical pins or terminals that connect to external hardware, for example the pins of a parallel port connector. To avoid confusion, these are referred to as *physical pins*. These are the things that *stick out* into the real world.

Signal

In a physical machine, the terminals of real hardware components are interconnected by wires. The HAL equivalent of a wire is a *signal* or *HAL signal*. HAL signals connect HAL pins together as required by the machine builder. HAL signals can be disconnected and reconnected at will (even while the machine is running).

Type

When using real hardware, you would not connect a 24 volt relay output to the +/-10V analog input of a servo amp. HAL pins have the same restrictions, which are based upon their type. Both pins and signals have types, and signals can only be connected to pins of the same type. Currently there are 4 types, as follows:

- bit - a single TRUE/FALSE or ON/OFF value
- float - a 64 bit floating point value, with approximately 53 bits of resolution and over 1000 bits of dynamic range.
- u32 - a 32 bit unsigned integer, legal values are 0 to 4,294,967,295
- s32 - a 32 bit signed integer, legal values are -2,147,483,647 to +2,147,483,647

Function

Real hardware components tend to act immediately on their inputs. For example, if the input voltage to a servo amp changes, the output also changes automatically. However software components cannot act *automatically*. Each component

has specific code that must be executed to do whatever that component is supposed to do. In some cases, that code simply runs as part of the component. However in most cases, especially in realtime components, the code must run in a specific sequence and at specific intervals. For example, inputs should be read before calculations are performed on the input data, and outputs should not be written until the calculations are done. In these cases, the code is made available to the system in the form of one or more *functions*. Each function is a block of code that performs a specific action. The system integrator can use *threads* to schedule a series of functions to be executed in a particular order and at specific time intervals.

Thread

A *thread* is a list of functions that runs at specific intervals as part of a realtime task. When a thread is first created, it has a specific time interval (period), but no functions. Functions can be added to the thread, and will be executed in order every time the thread runs.

As an example, suppose we have a parport component named `hal_parport`. That component defines one or more HAL pins for each physical pin. The pins are described in that component's doc section: their names, how each pin relates to the physical pin, are they inverted, can you change polarity, etc. But that alone doesn't get the data from the HAL pins to the physical pins. It takes code to do that, and that is where functions come into the picture. The parport component needs at least two functions: one to read the physical input pins and update the HAL pins, the other to take data from the HAL pins and write it to the physical output pins. Both of these functions are part of the parport driver.

1.3 HAL components

Each HAL component is a piece of software with well-defined inputs, outputs, and behavior, that can be installed and interconnected as needed. This section lists some of the available components and a brief description of what each does. Complete details for each component are available later in this document.

1.3.1 External Programs with HAL hooks

motion

A realtime module that accepts NML ¹ motion commands and interacts with HAL

iocontrol

A user space module that accepts NML I/O commands and interacts with HAL

classicladder

A PLC using HAL for all I/O

halui

A user space program that interacts with HAL and sends NML commands, it is intended to work as a full User Interface using external knobs & switches

1.3.2 Internal Components

stepgen

Software step pulse generator with position loop. See section Section 9.1

encoder

Software based encoder counter. See section Section 9.3

pid

Proportional/Integral/Derivative control loops. See section Section 9.4

siggen

A sine/cosine/triangle/square wave generator for testing. See section [sec:Siggen]

¹ Neutral Message Language provides a mechanism for handling multiple types of messages in the same buffer as well as simplifying the interface for encoding and decoding buffers in neutral format and the configuration mechanism.

supply

a simple source for testing

blocks

assorted useful components (mux, demux, or, and, integ, ddt, limit, wcomp, etc.)

1.3.3 Hardware Drivers

hal_ax5214h

A driver for the Axiom Measurement & Control AX5241H digital I/O board

hal_m5i20

Mesa Electronics 5i20 board

hal_motenc

Vital Systems MOTENC-100 board

hal_parport

PC parallel port.

hal_ppmc

Pico Systems family of controllers (PPMC, USC and UPC)

hal_stg

Servo To Go card (version 1 & 2)

hal_vti

Vigilant Technologies PCI ENCDAC-4 controller

1.3.4 Tools and Utilities

halcmd

Command line tool for configuration and tuning. See section [\[sec:Halcmd\]](#)

halgui

GUI tool for configuration and tuning (not implemented yet).

halmeter

A handy multimeter for HAL signals. See section [\[sec:Halmeter\]](#).

halscope

A full featured digital storage oscilloscope for HAL signals. See section [\[sec:Halscope\]](#).

Each of these building blocks is described in detail in later chapters.

1.4 Timing Issues In HAL

Unlike the physical wiring models between black boxes that we have said that HAL is based upon, simply connecting two pins with a hal-signal falls far short of the action of the physical case.

True relay logic consists of relays connected together, and when a contact opens or closes, current flows (or stops) immediately. Other coils may change state, etc, and it all just *happens*. But in PLC style ladder logic, it doesn't work that way. Usually in a single pass through the ladder, each rung is evaluated in the order in which it appears, and only once per pass. A perfect example is a single rung ladder, with a NC contact in series with a coil. The contact and coil belong to the same relay.

If this were a conventional relay, as soon as the coil is energized, the contacts begin to open and de-energize it. That means the contacts close again, etc, etc. The relay becomes a buzzer.

With a PLC, if the coil is OFF and the contact is closed when the PLC begins to evaluate the rung, then when it finishes that pass, the coil is ON. The fact that turning on the coil opens the contact feeding it is ignored until the next pass. On the next pass, the PLC sees that the contact is open, and de-energizes the coil. So the relay still switches rapidly between on and off, but at a rate determined by how often the PLC evaluates the rung.

In HAL, the function is the code that evaluates the rung(s). In fact, the HAL-aware realtime version of ClassicLadder exports a function to do exactly that. Meanwhile, a thread is the thing that runs the function at specific time intervals. Just like you can choose to have a PLC evaluate all its rungs every 10 ms, or every second, you can define HAL threads with different periods.

What distinguishes one thread from another is *not* what the thread does - that is determined by which functions are connected to it. The real distinction is simply how often a thread runs.

In LinuxCNC you might have a 50 us thread and a 1 ms thread. These would be created based on `BASE_PERIOD` and `SERVO_PERIOD`, the actual times depend on the values in your ini file.

The next step is to decide what each thread needs to do. Some of those decisions are the same in (nearly) any LinuxCNC system—For instance, motion-command-handler is always added to servo-thread.

Other connections would be made by the integrator. These might include hooking the STG driver's encoder read and DAC write functions to the servo thread, or hooking stepgen's function to the base-thread, along with the parport function(s) to write the steps to the port.

Chapter 2

Advanced HAL Tutorial

2.1 Introduction

Configuration moves from theory to device — HAL device that is. For those who have had just a bit of computer programming, this section is the *Hello World* of the HAL. Halrun can be used to create a working system. It is a command line or text file tool for configuration and tuning. The following examples illustrate its setup and operation.

2.1.1 Notation

Terminal commands are shown without the system prompt unless you are running *HAL*. The terminal window is in *Application-Accessories* from the main Ubuntu menu bar.

Terminal Command Example

```
me@computer:~linuxcnc$ halrun
(will be shown like the following line)
halrun

(the halcmd: prompt will be shown when running HAL)
halcmd: loadrt debounce
halcmd: show pin
```

2.1.2 Tab-completion

Your version of halcmd may include tab-completion. Instead of completing file names as a shell does, it completes commands with HAL identifiers. You will have to type enough letters for a unique match. Try pressing tab after starting a HAL command:

Tab Completion

```
halcmd: loa<TAB>
halcmd: load
halcmd: loadrt
halcmd: loadrt deb<TAB>
halcmd: loadrt debounce
```

2.1.3 The RTAPI environment

RTAPI stands for Real Time Application Programming Interface. Many HAL components work in realtime, and all HAL components store data in shared memory so realtime components can access it. Normal Linux does not support realtime programming

or the type of shared memory that HAL needs. Fortunately there are realtime operating systems (RTOS's) that provide the necessary extensions to Linux. Unfortunately, each RTOS does things a little differently.

To address these differences, the LinuxCNC team came up with RTAPI, which provides a consistent way for programs to talk to the RTOS. If you are a programmer who wants to work on the internals of LinuxCNC, you may want to study *linuxcnc/src/rtapi/rtapi.h* to understand the API. But if you are a normal person all you need to know about RTAPI is that it (and the RTOS) needs to be loaded into the memory of your computer before you do anything with HAL.

2.2 A Simple Example

2.2.1 Loading a component

For this tutorial, we are going to assume that you have successfully installed the Live CD and, if using a RIP ¹, invoked the *rip-environment* script to prepare your shell. In that case, all you need to do is load the required RTOS and RTAPI modules into memory. Just run the following command from a terminal window:

Loading HAL

```
cd linuxcnc
halrun
halcmd:
```

With the realtime OS and RTAPI loaded, we can move into the first example. Notice that the prompt is now shown as *halcmd:*. This is because subsequent commands will be interpreted as HAL commands, not shell commands.

For the first example, we will use a HAL component called *siggen*, which is a simple signal generator. A complete description of the *siggen* component can be found in the [Siggen](#) section of this Manual. It is a realtime component, implemented as a Linux kernel module. To load *siggen* use the HAL command *loadrt*.

Loading siggen

```
halcmd: loadrt siggen
```

2.2.2 Examining the HAL

Now that the module is loaded, it is time to introduce *halcmd*, the command line tool used to configure the HAL. This tutorial will introduce some *halcmd* features, for a more complete description try *man halcmd*, or see the reference in [Hal Commands](#) section of this document. The first *halcmd* feature is the *show* command. This command displays information about the current state of the HAL. To show all installed components:

Show Components

```
halcmd: show comp

Loaded HAL Components:
ID      Type  Name          PID   State
  3     RT   siggen              ready
  2     User halcmd2177    2177  ready
```

Since *halcmd* itself is a HAL component, it will always show up in the list. The number after *halcmd* in the component list is the process ID. It is possible to run more than one copy of *halcmd* at the same time (in different windows for example), so the PID is added to the end of the name to make it unique. The list also shows the *siggen* component that we installed in the previous step. The *RT* under *Type* indicates that *siggen* is a realtime component. The *User* under *Type* indicates it is a user space component.

Next, let's see what pins *siggen* makes available:

Show Pins

¹ Run In Place, when the source files have been downloaded to a user directory.

```
halcmd: show pin
```

```
Component Pins:
```

Owner	Type	Dir	Value	Name
3	float	IN	1	siggen.0.amplitude
3	bit	OUT	FALSE	siggen.0.clock
3	float	OUT	0	siggen.0.cosine
3	float	IN	1	siggen.0.frequency
3	float	IN	0	siggen.0.offset
3	float	OUT	0	siggen.0.sawtooth
3	float	OUT	0	siggen.0.sine
3	float	OUT	0	siggen.0.square
3	float	OUT	0	siggen.0.triangle

This command displays all of the pins in the current HAL. A complex system could have dozens or hundreds of pins. But right now there are only nine pins. All eight of these pins are floating point, and carry data out of the *siggen* component. Since we have not yet executed the code contained within the component, some the pins have a value of zero.

The next step is to look at parameters:

Show Parameters

```
halcmd: show param
```

```
Parameters:
```

Owner	Type	Dir	Value	Name
3	s32	RO	0	siggen.0.update.time
3	s32	RW	0	siggen.0.update.tmax

The *show param* command shows all the parameters in the HAL. Right now each parameter has the default value it was given when the component was loaded. Note the column labeled *Dir*. The parameters labeled *-W* are writable ones that are never changed by the component itself, instead they are meant to be changed by the user to control the component. We will see how to do this later. Parameters labeled *R-* are read only parameters. They can be changed only by the component. Finally, parameter labeled *RW* are read-write parameters. That means that they are changed by the component, but can also be changed by the user. Note: the parameters *siggen.0.update.time* and *siggen.0.update.tmax* are for debugging purposes, and won't be covered in this section.

Most realtime components export one or more functions to actually run the realtime code they contain. Let's see what function(s) *siggen* exported:

Show Functions

```
halcmd: show funct
```

```
Exported Functions:
```

Owner	CodeAddr	Arg	FP	Users	Name
00003	f801b000	fae820b8	YES	0	siggen.0.update

The *siggen* component exported a single function. It requires floating point. It is not currently linked to any threads, so *users* is zero.

2.2.3 Making realtime code run

To actually run the code contained in the function *siggen.0.update*, we need a realtime thread. The component called *threads* that is used to create a new thread. Lets create a thread called *test-thread* with a period of 1 ms (1,000 us or 1,000,000 ns):

```
halcmd: loadrt threads name1=test-thread period1=1000000
```

Let's see if that worked:

Show Threads

```
halcmd: show thread
```

```
Realtime Threads:
```

Period	FP	Name	(Time,	Max-Time)
999855	YES	test-thread	(0,	0)

It did. The period is not exactly 1,000,000 ns because of hardware limitations, but we have a thread that runs at approximately the correct rate, and which can handle floating point functions. The next step is to connect the function to the thread:

Add Function

```
halcmd: addf siggen.0.update test-thread
```

Up till now, we've been using *halcmd* only to look at the HAL. However, this time we used the *addf* (add function) command to actually change something in the HAL. We told *halcmd* to add the function *siggen.0.update* to the thread *test-thread*, and if we look at the thread list again, we see that it succeeded:

```
halcmd: show thread
```

```
Realtime Threads:
```

Period	FP	Name	(Time,	Max-Time)
999855	YES	test-thread	(0,	0)
		1 siggen.0.update				

There is one more step needed before the *siggen* component starts generating signals. When the HAL is first started, the thread(s) are not actually running. This is to allow you to completely configure the system before the realtime code starts. Once you are happy with the configuration, you can start the realtime code like this:

```
halcmd: start
```

Now the signal generator is running. Let's look at its output pins:

```
halcmd: show pin
```

```
Component Pins:
```

Owner	Type	Dir	Value	Name
3	float	IN	1	siggen.0.amplitude
3	bit	OUT	FALSE	siggen.0.clock
3	float	OUT	-0.1640929	siggen.0.cosine
3	float	IN	1	siggen.0.frequency
3	float	IN	0	siggen.0.offset
3	float	OUT	-0.4475303	siggen.0.sawtooth
3	float	OUT	0.9864449	siggen.0.sine
3	float	OUT	-1	siggen.0.square
3	float	OUT	-0.1049393	siggen.0.triangle

And let's look again:

```
halcmd: show pin
```

```
Component Pins:
```

Owner	Type	Dir	Value	Name
3	float	IN	1	siggen.0.amplitude
3	bit	OUT	FALSE	siggen.0.clock
3	float	OUT	0.0507619	siggen.0.cosine
3	float	IN	1	siggen.0.frequency
3	float	IN	0	siggen.0.offset
3	float	OUT	-0.516165	siggen.0.sawtooth
3	float	OUT	0.9987108	siggen.0.sine
3	float	OUT	-1	siggen.0.square
3	float	OUT	0.03232994	siggen.0.triangle

We did two `show pin` commands in quick succession, and you can see that the outputs are no longer zero. The sine, cosine, sawtooth, and triangle outputs are changing constantly. The square output is also working, however it simply switches from +1.0 to -1.0 every cycle.

2.2.4 Changing Parameters

The real power of HAL is that you can change things. For example, we can use the `setp` command to set the value of a parameter. Let's change the amplitude of the signal generator from 1.0 to 5.0:

Set Pin

```
halcmd: setp siggen.0.amplitude 5
```

Check the parameters and pins again

```
halcmd: show param
```

Parameters:

Owner	Type	Dir	Value	Name
3	s32	RO	1754	siggen.0.update.time
3	s32	RW	16997	siggen.0.update.tmax

```
halcmd: show pin
```

Component Pins:

Owner	Type	Dir	Value	Name
3	float	IN	5	siggen.0.amplitude
3	bit	OUT	FALSE	siggen.0.clock
3	float	OUT	0.8515425	siggen.0.cosine
3	float	IN	1	siggen.0.frequency
3	float	IN	0	siggen.0.offset
3	float	OUT	2.772382	siggen.0.sawtooth
3	float	OUT	-4.926954	siggen.0.sine
3	float	OUT	5	siggen.0.square
3	float	OUT	0.544764	siggen.0.triangle

Note that the value of parameter `siggen.0.amplitude` has changed to 5, and that the pins now have larger values.

2.2.5 Saving the HAL configuration

Most of what we have done with `halcmd` so far has simply been viewing things with the `show` command. However two of the commands actually changed things. As we design more complex systems with HAL, we will use many commands to configure things just the way we want them. HAL has the memory of an elephant, and will retain that configuration until we shut it down. But what about next time? We don't want to manually enter a bunch of commands every time we want to use the system. We can save the configuration of the entire HAL with a single command:

Save

```
halcmd: save
# components
loadrt threads name1=test-thread period1=1000000
loadrt siggen
# pin aliases
# signals
# nets
# parameter values
setp siggen.0.update.tmax 14687
# realtime thread/function links
addf siggen.0.update test-thread
```

The output of the *save* command is a sequence of HAL commands. If you start with an *empty* HAL and run all these commands, you will get the configuration that existed when the *save* command was issued. To save these commands for later use, we simply redirect the output to a file:

Save to a file

```
halcmd: save all saved.hal
```

2.2.6 Exiting halrun

When you're finished with your HAL session type *exit* at the *halcmd:* prompt. This will return you to the system prompt and close down the HAL session. Do not simply close the terminal window without shutting down the HAL session.

Exit HAL

```
halcmd: exit
```

2.2.7 Restoring the HAL configuration

To restore the HAL configuration stored in *saved.hal*, we need to execute all of those HAL commands. To do that, we use *-f <file name>* which reads commands from a file, and *-I* (upper case i) which shows the *halcmd* prompt after executing the commands:

Run a Saved File

```
halrun -I -f saved.hal
```

Notice that there is not a *start* command in *saved.hal*. It's necessary to issue it again (or edit *saved.hal* to add it there).

2.2.8 Removing HAL from memory

If an unexpected shut down of a HAL session occurs you might have to unload HAL before another session can begin. To do this type the following command in a terminal window.

Removing HAL

```
halrun -U
```

2.3 Halmeter

You can build very complex HAL systems without ever using a graphical interface. However there is something satisfying about seeing the result of your work. The first and simplest GUI tool for the HAL is *halmeter*. It is a very simple program that is the HAL equivalent of the handy Fluke multimeter (or Simpson analog meter for the old timers).

We will use the *siggen* component again to check out *halmeter*. If you just finished the previous example, then you can load *siggen* using the saved file. If not, we can load it just like we did before:

```
halrun
halcmd: loadrt siggen
halcmd: loadrt threads name1=test-thread period1=1000000
halcmd: addf siggen.0.update test-thread
halcmd: start
halcmd: setp siggen.0.amplitude 5
```

At this point we have the *siggen* component loaded and running. It's time to start *halmeter*.

Starting Halmeter

```
halcmd: loadusr halmeter
```

The first window you will see is the *Select Item to Probe* window.

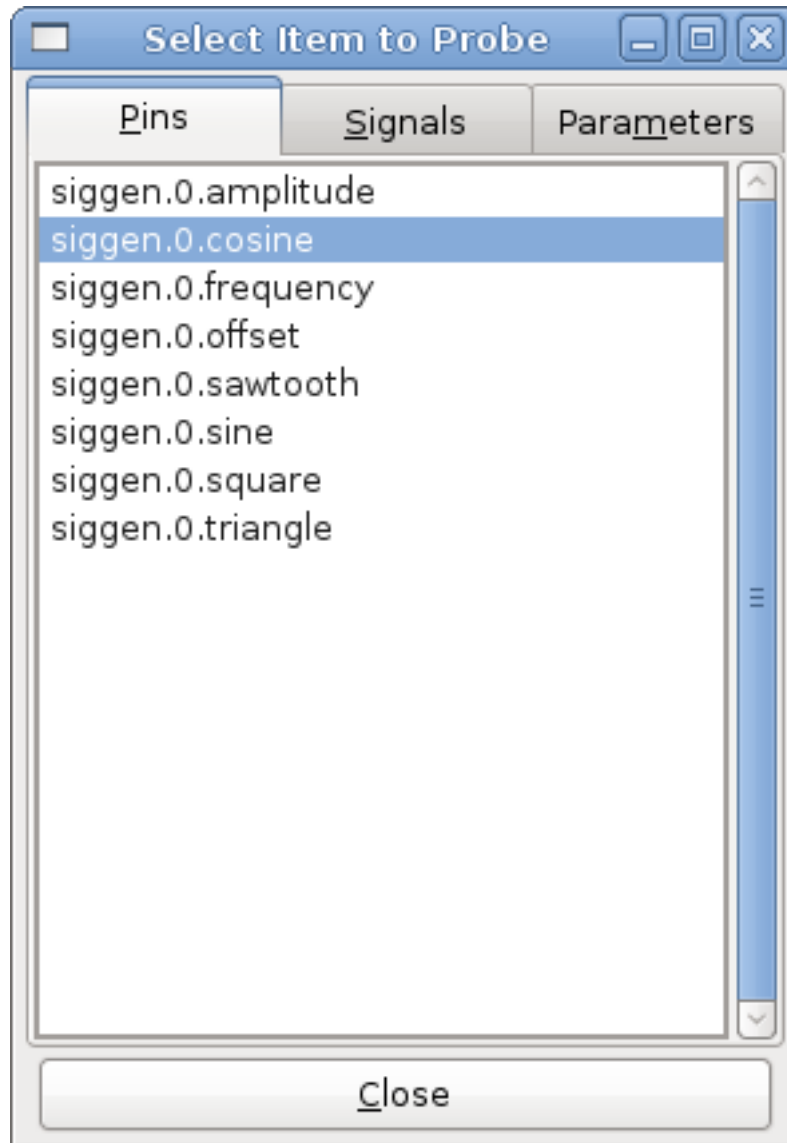

Figure 2.1: Halmeter Select Window

This dialog has three tabs. The first tab displays all of the HAL pins in the system. The second one displays all the signals, and the third displays all the parameters. We would like to look at the pin *siggen.0.cosine* first, so click on it then click the *Close* button. The probe selection dialog will close, and the meter looks something like the following figure.

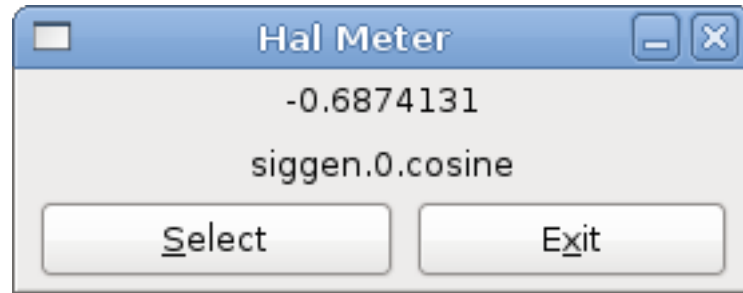

Figure 2.2: Halmeter

To change what the meter displays press the *Select* button which brings back the *Select Item to Probe* window.

You should see the value changing as siggen generates its cosine wave. Halmeter refreshes its display about 5 times per second.

To shut down halmeter, just click the exit button.

If you want to look at more than one pin, signal, or parameter at a time, you can just start more halmeters. The halmeter window was intentionally made very small so you could have a lot of them on the screen at once.

2.4 Stepgen Example

Up till now we have only loaded one HAL component. But the whole idea behind the HAL is to allow you to load and connect a number of simple components to make up a complex system. The next example will use two components.

Before we can begin building this new example, we want to start with a clean slate. If you just finished one of the previous examples, we need to remove the all components and reload the RTAPI and HAL libraries.

```
halcmd: exit
```

2.4.1 Installing the components

Now we are going to load the step pulse generator component. For a detailed description of this component refer to the stepgen section of the Integrator Manual. In this example we will use the *velocity* control type of stepgen. For now, we can skip the details, and just run the following commands.

```
halrun
halcmd: loadrt stepgen step_type=0,0 ctrl_type=v,v
halcmd: loadrt siggen
halcmd: loadrt threads name1=fast fp1=0 period1=50000 name2=slow period2=1000000
```

The first command loads two step generators, both configured to generate stepping type 0. The second command loads our old friend siggen, and the third one creates two threads, a fast one with a period of 50 microseconds and a slow one with a period of 1 millisecond. The fast thread doesn't support floating point functions.

As before, we can use *halcmd show* to take a look at the HAL. This time we have a lot more pins and parameters than before:

```
halcmd: show pin

Component Pins:
Owner  Type  Dir      Value  Name
  4  float IN      1  siggen.0.amplitude
  4  bit   OUT     FALSE  siggen.0.clock
  4  float OUT     0  siggen.0.cosine
  4  float IN      1  siggen.0.frequency
  4  float IN      0  siggen.0.offset
```

```

4 float OUT          0 siggen.0.sawtooth
4 float OUT          0 siggen.0.sine
4 float OUT          0 siggen.0.square
4 float OUT          0 siggen.0.triangle
3 s32  OUT           0 stepgen.0.counts
3 bit  OUT           FALSE stepgen.0.dir
3 bit  IN            FALSE stepgen.0.enable
3 float OUT          0 stepgen.0.position-fb
3 bit  OUT           FALSE stepgen.0.step
3 float IN           0 stepgen.0.velocity-cmd
3 s32  OUT           0 stepgen.1.counts
3 bit  OUT           FALSE stepgen.1.dir
3 bit  IN            FALSE stepgen.1.enable
3 float OUT          0 stepgen.1.position-fb
3 bit  OUT           FALSE stepgen.1.step
3 float IN           0 stepgen.1.velocity-cmd

```

```
halcmd: show param
```

```
Parameters:
```

Owner	Type	Dir	Value	Name
4	s32	RO	0	siggen.0.update.time
4	s32	RW	0	siggen.0.update.tmax
3	u32	RW	0x00000001	stepgen.0.dirhold
3	u32	RW	0x00000001	stepgen.0.dirsetup
3	float	RO	0	stepgen.0.frequency
3	float	RW	0	stepgen.0.maxaccel
3	float	RW	0	stepgen.0.maxvel
3	float	RW	1	stepgen.0.position-scale
3	s32	RO	0	stepgen.0.rawcounts
3	u32	RW	0x00000001	stepgen.0.steplen
3	u32	RW	0x00000001	stepgen.0.stepspace
3	u32	RW	0x00000001	stepgen.1.dirhold
3	u32	RW	0x00000001	stepgen.1.dirsetup
3	float	RO	0	stepgen.1.frequency
3	float	RW	0	stepgen.1.maxaccel
3	float	RW	0	stepgen.1.maxvel
3	float	RW	1	stepgen.1.position-scale
3	s32	RO	0	stepgen.1.rawcounts
3	u32	RW	0x00000001	stepgen.1.steplen
3	u32	RW	0x00000001	stepgen.1.stepspace
3	s32	RO	0	stepgen.capture-position.time
3	s32	RW	0	stepgen.capture-position.tmax
3	s32	RO	0	stepgen.make-pulses.time
3	s32	RW	0	stepgen.make-pulses.tmax
3	s32	RO	0	stepgen.update-freq.time
3	s32	RW	0	stepgen.update-freq.tmax

2.4.2 Connecting pins with signals

What we have is two step pulse generators, and a signal generator. Now it is time to create some HAL signals to connect the two components. We are going to pretend that the two step pulse generators are driving the X and Y axis of a machine. We want to move the table in circles. To do this, we will send a cosine signal to the X axis, and a sine signal to the Y axis. The siggen module creates the sine and cosine, but we need *wires* to connect the modules together. In the HAL, *wires* are called signals. We need to create two of them. We can call them anything we want, for this example they will be *X-vel* and *Y-vel*. The signal *X-vel* is intended to run from the cosine output of the signal generator to the velocity input of the first step pulse generator. The first step is to connect the signal to the signal generator output. To connect a signal to a pin we use the net command.

net command

```
halcmd: net X-vel <= siggen.0.cosine
```

To see the effect of the *net* command, we show the signals again.

```
halcmd: show sig
```

```
Signals:
Type      Value  Name      (linked to)
float     0      X-vel <= siggen.0.cosine
```

When a signal is connected to one or more pins, the show command lists the pins immediately following the signal name. The *arrow* shows the direction of data flow - in this case, data flows from pin *siggen.0.cosine* to signal *X-vel*. Now let's connect the *X-vel* to the velocity input of a step pulse generator.

```
halcmd: net X-vel => stepgen.0.velocity-cmd
```

We can also connect up the Y axis signal *Y-vel*. It is intended to run from the sine output of the signal generator to the input of the second step pulse generator. The following command accomplishes in one line what two *net* commands accomplished for *X-vel*.

```
halcmd: net Y-vel siggen.0.sine => stepgen.1.velocity-cmd
```

Now let's take a final look at the signals and the pins connected to them.

```
halcmd: show sig
```

```
Signals:
Type      Value  Name      (linked to)
float     0      X-vel <= siggen.0.cosine
          ==> stepgen.0.velocity-cmd
float     0      Y-vel <= siggen.0.sine
          ==> stepgen.1.velocity-cmd
```

The *show sig* command makes it clear exactly how data flows through the HAL. For example, the *X-vel* signal comes from pin *siggen.0.cosine*, and goes to pin *stepgen.0.velocity-cmd*.

2.4.3 Setting up realtime execution - threads and functions

Thinking about data flowing through *wires* makes pins and signals fairly easy to understand. Threads and functions are a little more difficult. Functions contain the computer instructions that actually get things done. Thread are the method used to make those instructions run when they are needed. First let's look at the functions available to us.

```
halcmd: show funct
```

```
Exported Functions:
Owner  CodeAddr  Arg      FP  Users  Name
00004  f9992000  fc731278 YES  0      siggen.0.update
00003  f998b20f  fc7310b8 YES  0      stepgen.capture-position
00003  f998b000  fc7310b8 NO   0      stepgen.make-pulses
00003  f998b307  fc7310b8 YES  0      stepgen.update-freq
```

In general, you will have to refer to the documentation for each component to see what its functions do. In this case, the function *siggen.0.update* is used to update the outputs of the signal generator. Every time it is executed, it calculates the values of the sine, cosine, triangle, and square outputs. To make smooth signals, it needs to run at specific intervals.

The other three functions are related to the step pulse generators.

The first one, *stepgen.capture_position*, is used for position feedback. It captures the value of an internal counter that counts the step pulses as they are generated. Assuming no missed steps, this counter indicates the position of the motor.

The main function for the step pulse generator is *stepgen.make_pulses*. Every time *make_pulses* runs it decides if it is time to take a step, and if so sets the outputs accordingly. For smooth step pulses, it should run as frequently as possible. Because it needs to run so fast, *make_pulses* is highly optimized and performs only a few calculations. Unlike the others, it does not need floating point math.

The last function, *stepgen.update-freq*, is responsible for doing scaling and some other calculations that need to be performed only when the frequency command changes.

What this means for our example is that we want to run *siggen.0.update* at a moderate rate to calculate the sine and cosine values. Immediately after we run *siggen.0.update*, we want to run *stepgen.update_freq* to load the new values into the step pulse generator. Finally we need to run *stepgen.make_pulses* as fast as possible for smooth pulses. Because we don't use position feedback, we don't need to run *stepgen.capture_position* at all.

We run functions by adding them to threads. Each thread runs at a specific rate. Let's see what threads we have available.

```
halcmd: show thread
```

```
Realtime Threads:
  Period  FP      Name          (      Time, Max-Time )
  996980  YES          slow (          0,      0 )
  49849   NO          fast (          0,      0 )
```

The two threads were created when we loaded *threads*. The first one, *slow*, runs every millisecond, and is capable of running floating point functions. We will use it for *siggen.0.update* and *stepgen.update_freq*. The second thread is *fast*, which runs every 50 microseconds, and does not support floating point. We will use it for *stepgen.make_pulses*. To connect the functions to the proper thread, we use the *addf* command. We specify the function first, followed by the thread.

```
halcmd: addf siggen.0.update slow
halcmd: addf stepgen.update-freq slow
halcmd: addf stepgen.make-pulses fast
```

After we give these commands, we can run the *show thread* command again to see what happened.

```
halcmd: show thread
```

```
Realtime Threads:
  Period  FP      Name          (      Time, Max-Time )
  996980  YES          slow (          0,      0 )
                1 siggen.0.update
                2 stepgen.update-freq
  49849   NO          fast (          0,      0 )
                1 stepgen.make-pulses
```

Now each thread is followed by the names of the functions, in the order in which the functions will run.

2.4.4 Setting parameters

We are almost ready to start our HAL system. However we still need to adjust a few parameters. By default, the *siggen* component generates signals that swing from +1 to -1. For our example that is fine, we want the table speed to vary from +1 to -1 inches per second. However the scaling of the step pulse generator isn't quite right. By default, it generates an output frequency of 1 step per second with an input of 1.000. It is unlikely that one step per second will give us one inch per second of table movement. Let's assume instead that we have a 5 turn per inch leadscrew, connected to a 200 step per rev stepper with 10x microstepping. So it takes 2000 steps for one revolution of the screw, and 5 revolutions to travel one inch. that means the overall scaling is 10000 steps per inch. We need to multiply the velocity input to the step pulse generator by 10000 to get the proper output. That is exactly what the parameter *stepgen.n.velocity-scale* is for. In this case, both the X and Y axis have the same scaling, so we set the scaling parameters for both to 10000.

```
halcmd: setp stepgen.0.position-scale 10000
halcmd: setp stepgen.1.position-scale 10000
halcmd: setp stepgen.0.enable 1
halcmd: setp stepgen.1.enable 1
```

This velocity scaling means that when the pin `stepgen.0.velocity-cmd` is 1.000, the step generator will generate 10000 pulses per second (10KHz). With the motor and leadscrew described above, that will result in the axis moving at exactly 1.000 inches per second. This illustrates a key HAL concept - things like scaling are done at the lowest possible level, in this case in the step pulse generator. The internal signal `X-vel` is the velocity of the table in inches per second, and other components such as `siggen` don't know (or care) about the scaling at all. If we changed the leadscrew, or motor, we would change only the scaling parameter of the step pulse generator.

2.4.5 Run it!

We now have everything configured and are ready to start it up. Just like in the first example, we use the `start` command.

```
halcmd: start
```

Although nothing appears to happen, inside the computer the step pulse generator is cranking out step pulses, varying from 10KHz forward to 10KHz reverse and back again every second. Later in this tutorial we'll see how to bring those internal signals out to run motors in the real world, but first we want to look at them and see what is happening.

2.5 Halscope

The previous example generates some very interesting signals. But much of what happens is far too fast to see with halmeter. To take a closer look at what is going on inside the HAL, we want an oscilloscope. Fortunately HAL has one, called halscope.

Halscope has two parts - a realtime part that is loaded as a kernel module, and a user part that supplies the GUI and display. However, you don't need to worry about this, because the userspace portion will automatically request that the realtime part be loaded. Also notice the first time you run halscope in a directory it gives a benign message that the file `autosave.halscope` could not be opened.

Starting Halscope

```
halcmd: loadusr halscope
halcmd: halscope: config file 'autosave.halscope' could not be opened
```

The scope GUI window will open, immediately followed by a *Realtime function not linked* dialog that looks like the following figure.

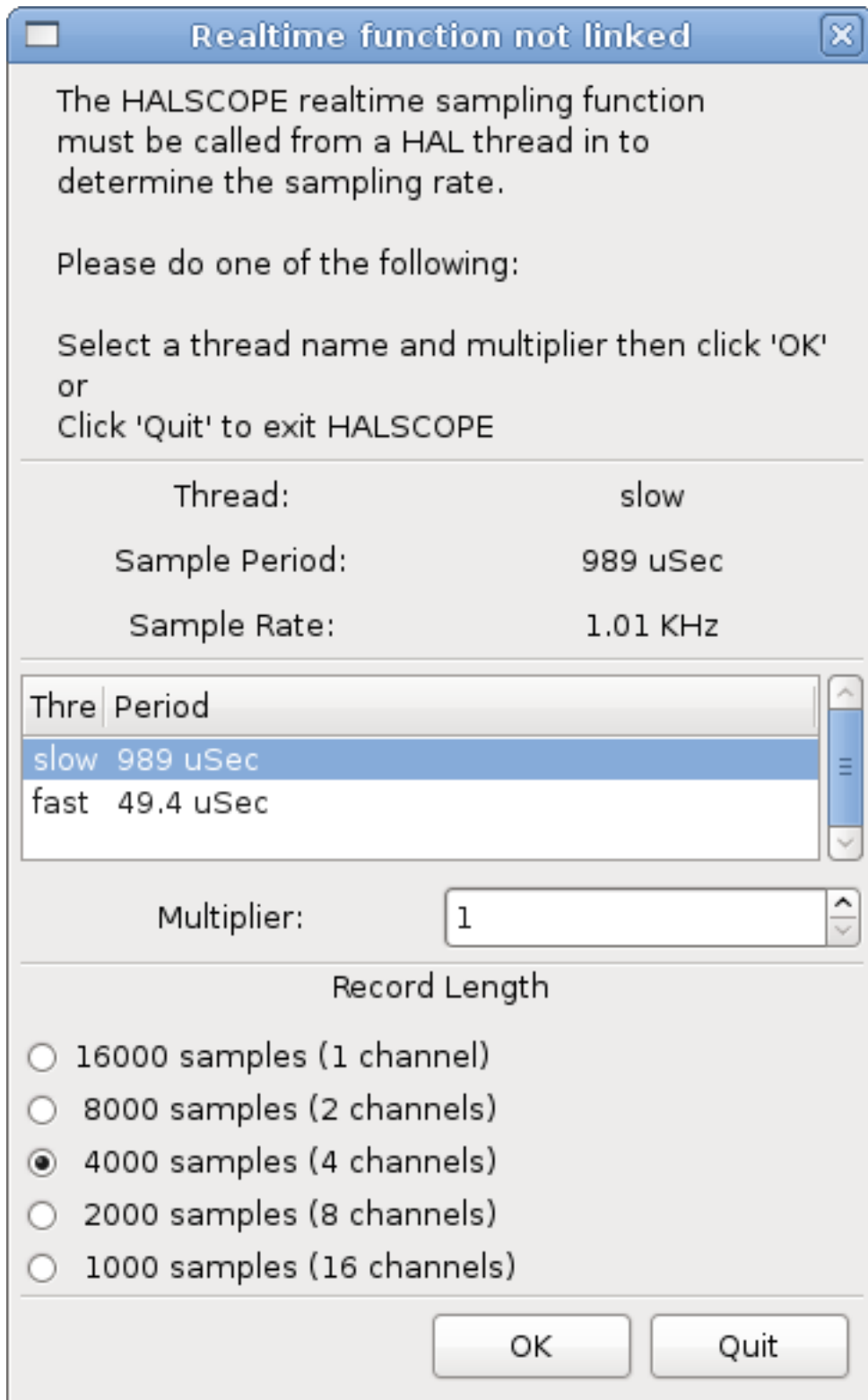

Figure 2.3: Realtime function not linked dialog

This dialog is where you set the sampling rate for the oscilloscope. For now we want to sample once per millisecond, so click on the 989 us thread *slow* and leave the multiplier at 1. We will also leave the record length at 4000 samples, so that we can use up to four channels at one time. When you select a thread and then click *OK*, the dialog disappears, and the scope window looks

something like the following figure.

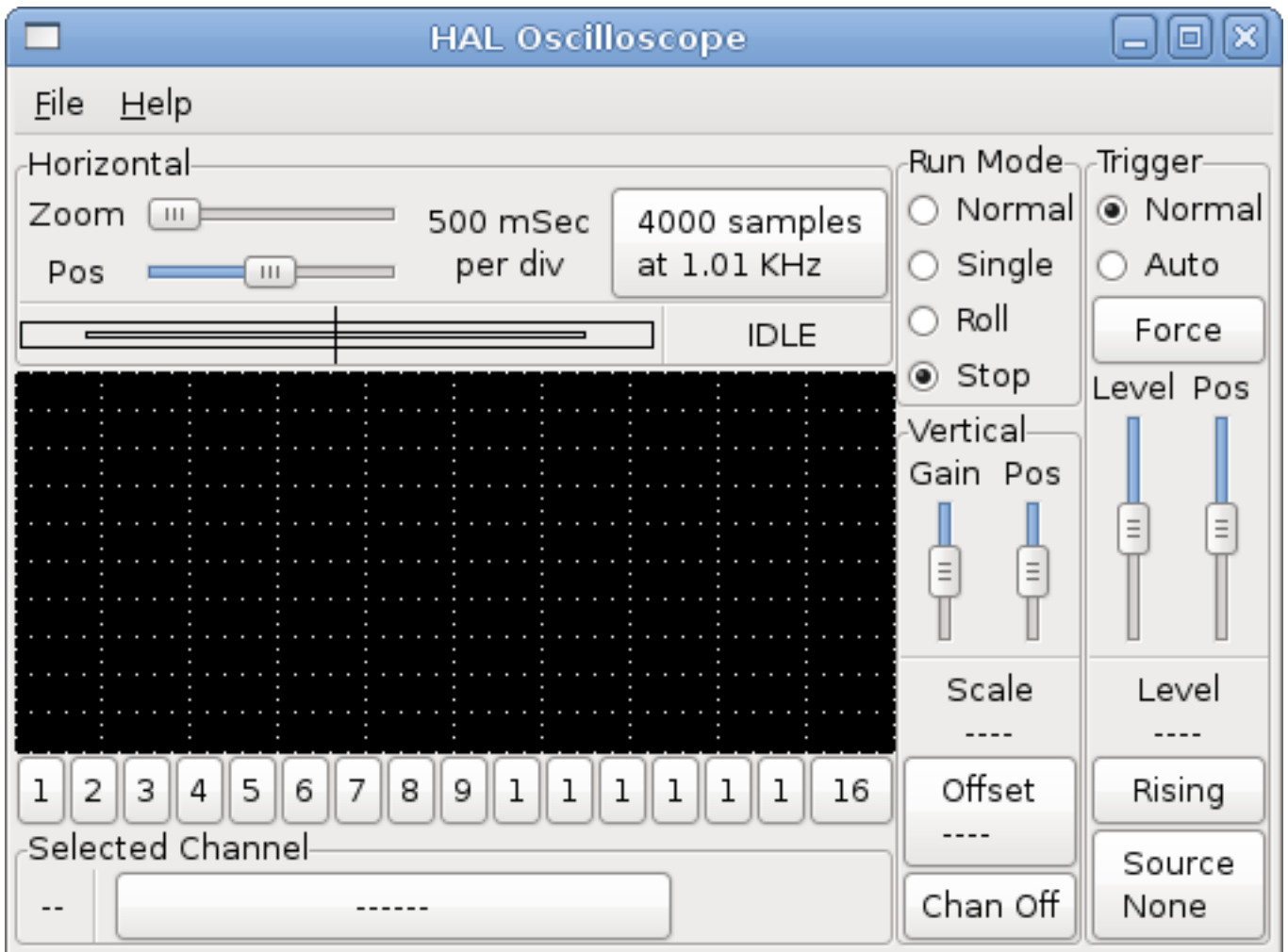

Figure 2.4: Initial scope window

2.5.1 Hooking up the scope probes

At this point, Halscope is ready to use. We have already selected a sample rate and record length, so the next step is to decide what to look at. This is equivalent to hooking *virtual scope probes* to the HAL. Halscope has 16 channels, but the number you can use at any one time depends on the record length - more channels means shorter records, since the memory available for the record is fixed at approximately 16,000 samples.

The channel buttons run across the bottom of the halscope screen. Click button 1, and you will see the *Select Channel Source* dialog as shown in the following figure. This dialog is very similar to the one used by Halmeter. We would like to look at the signals we defined earlier, so we click on the *Signals* tab, and the dialog displays all of the signals in the HAL (only two for this example).

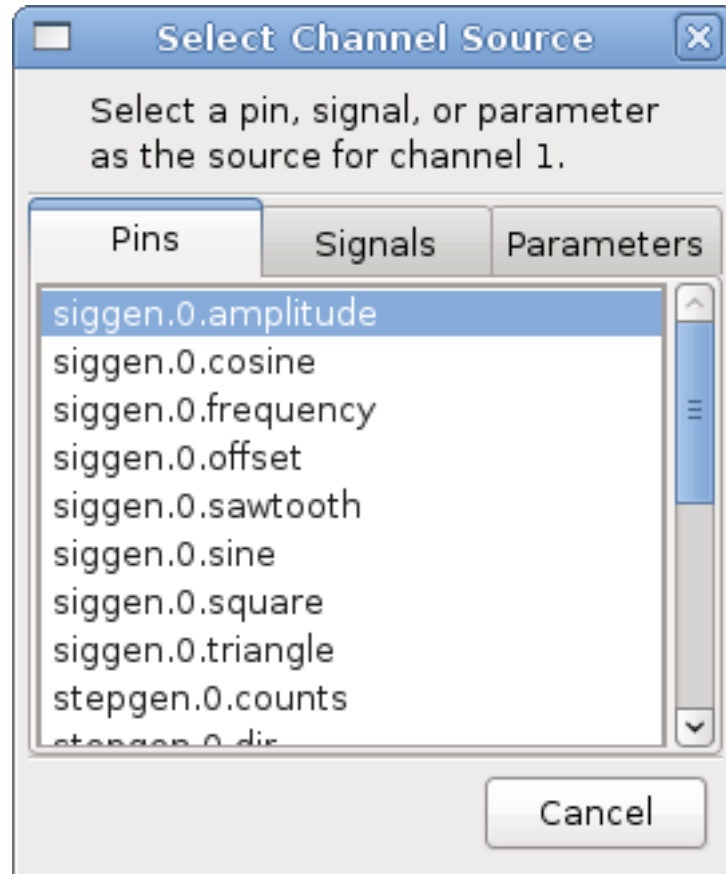

Figure 2.5: Select Channel Source

To choose a signal, just click on it. In this case, we want channel 1 to display the signal *X-vel*. Click on the Signals tab then click on *X-vel* and the dialog closes and the channel is now selected.

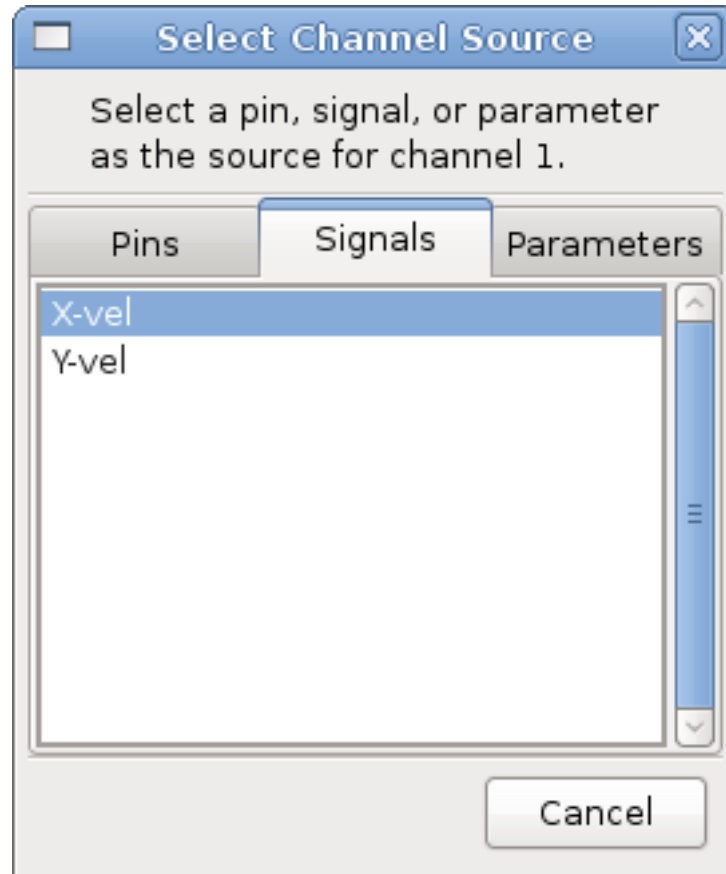

Figure 2.6: Select Signal

The channel 1 button is pressed in, and channel number 1 and the name *X-vel* appear below the row of buttons. That display always indicates the selected channel - you can have many channels on the screen, but the selected one is highlighted, and the various controls like vertical position and scale always work on the selected one.

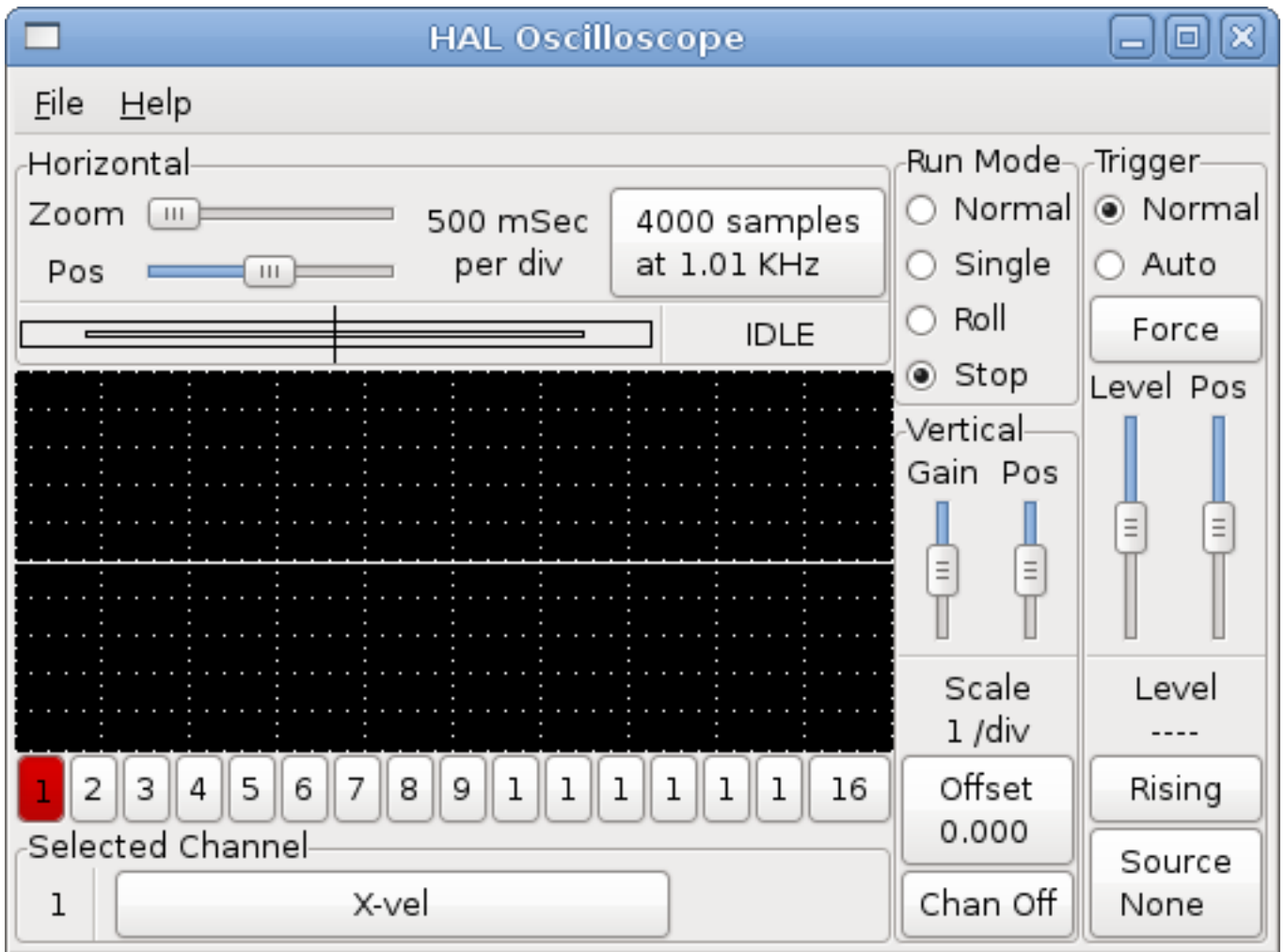

Figure 2.7: Halscope

To add a signal to channel 2, click the 2 button. When the dialog pops up, click the *Signals* tab, then click on *Y-vel*. We also want to look at the square and triangle wave outputs. There are no signals connected to those pins, so we use the *Pins* tab instead. For channel 3, select *siggen.0.triangle* and for channel 4, select *siggen.0.square*.

2.5.2 Capturing our first waveforms

Now that we have several probes hooked to the HAL, it's time to capture some waveforms. To start the scope, click the *Normal* button in the *Run Mode* section of the screen (upper right). Since we have a 4000 sample record length, and are acquiring 1000 samples per second, it will take halscope about 2 seconds to fill half of its buffer. During that time a progress bar just above the main screen will show the buffer filling. Once the buffer is half full, the scope waits for a trigger. Since we haven't configured one yet, it will wait forever. To manually trigger it, click the *Force* button in the *Trigger* section at the top right. You should see the remainder of the buffer fill, then the screen will display the captured waveforms. The result will look something like the following figure.

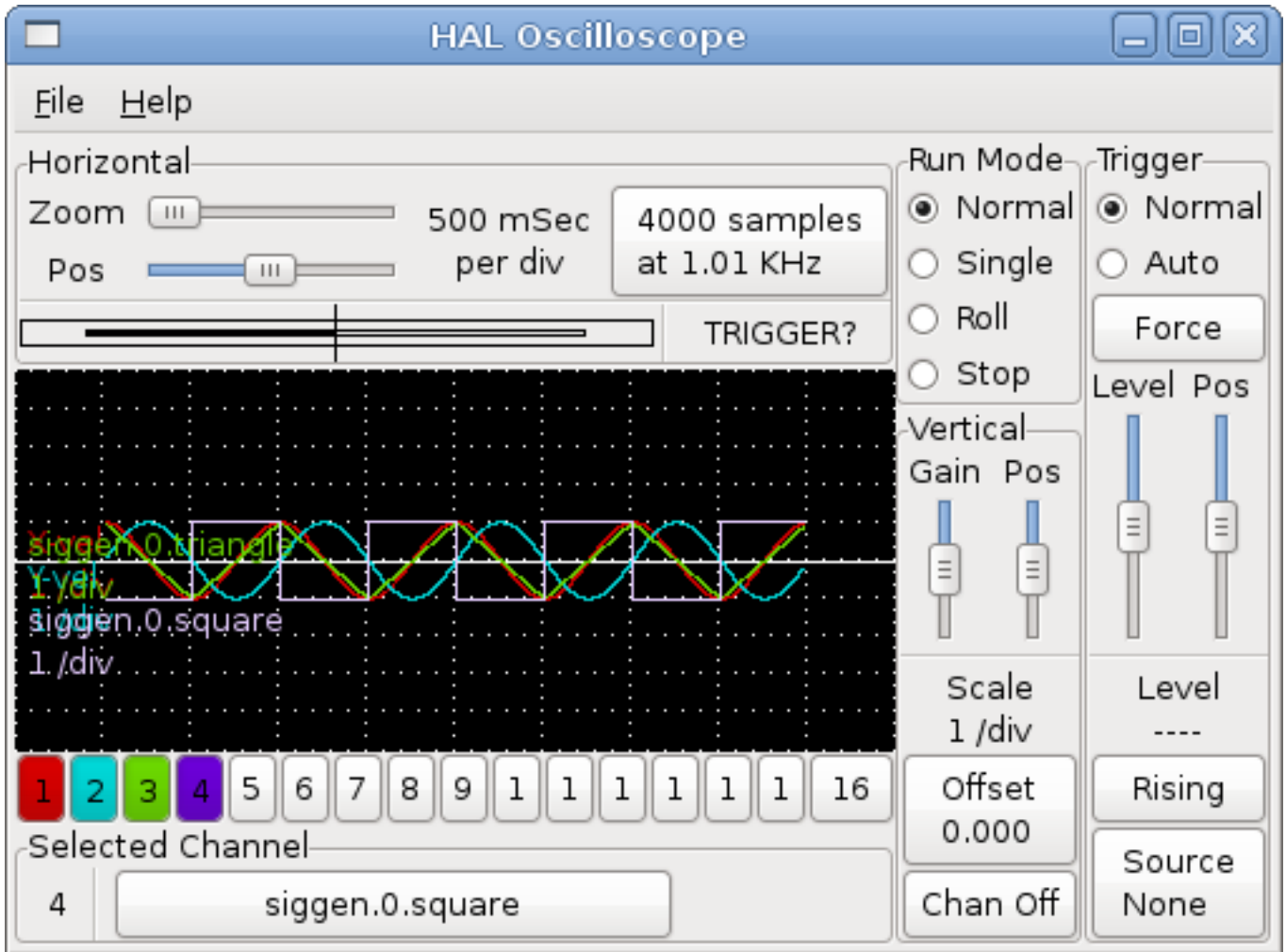

Figure 2.8: Captured Waveforms

The *Selected Channel* box at the bottom tells you that the purple trace is the currently selected one, channel 4, which is displaying the value of the pin *sigen.0.square*. Try clicking channel buttons 1 through 3 to highlight the other three traces.

2.5.3 Vertical Adjustments

The traces are rather hard to distinguish since all four are on top of each other. To fix this, we use the *Vertical* controls in the box to the right of the screen. These controls act on the currently selected channel. When adjusting the gain, notice that it covers a huge range - unlike a real scope, this one can display signals ranging from very tiny (pico-units) to very large (Tera-units). The position control moves the displayed trace up and down over the height of the screen only. For larger adjustments the offset button should be used.

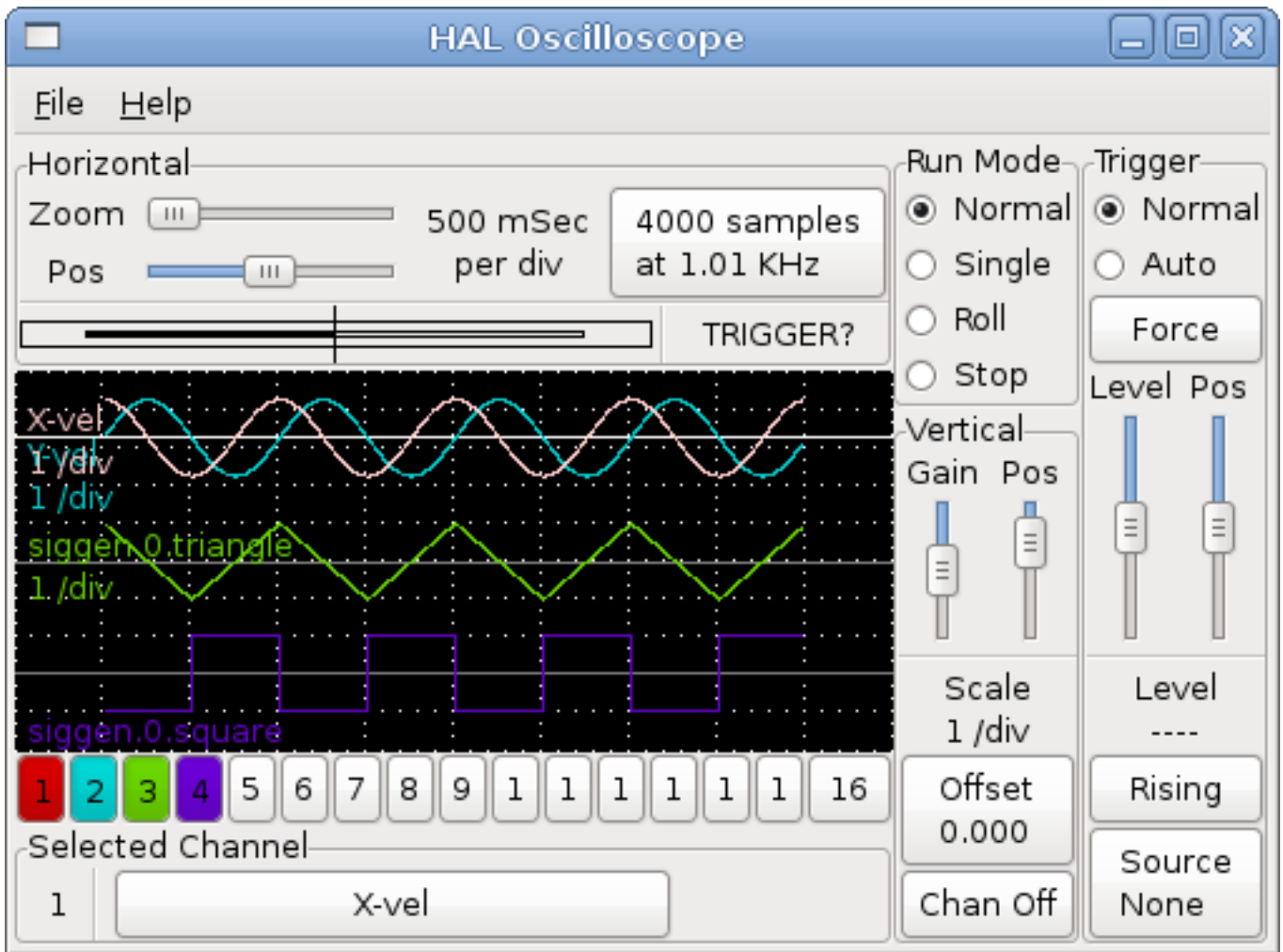

Figure 2.9: Vertical Adjustment

2.5.4 Triggering

Using the *Force* button is a rather unsatisfying way to trigger the scope. To set up real triggering, click on the *Source* button at the bottom right. It will pop up the *Trigger Source* dialog, which is simply a list of all the probes that are currently connected. Select a probe to use for triggering by clicking on it. For this example we will use channel 3, the triangle wave as shown in the following figure.

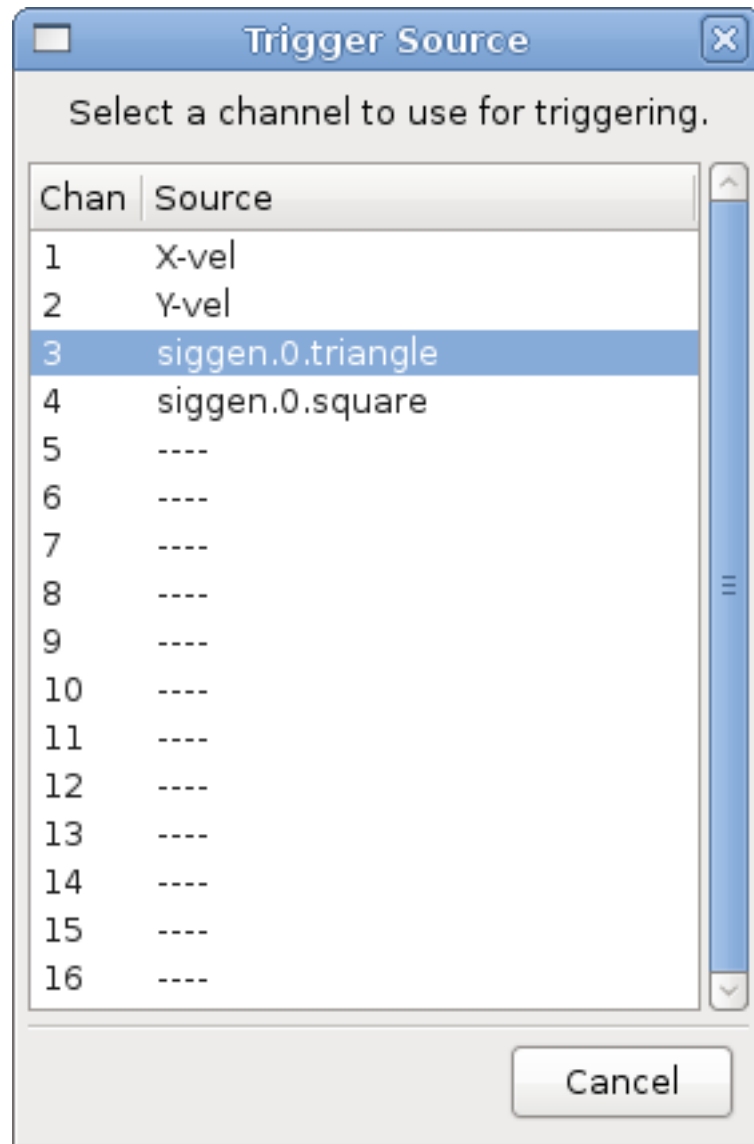

Figure 2.10: Trigger Source Dialog

After setting the trigger source, you can adjust the trigger level and trigger position using the sliders in the *Trigger* box along the right edge. The level can be adjusted from the top to the bottom of the screen, and is displayed below the sliders. The position is the location of the trigger point within the overall record. With the slider all the way down, the trigger point is at the end of the record, and halscope displays what happened before the trigger point. When the slider is all the way up, the trigger point is at the beginning of the record, displaying what happened after it was triggered. The trigger point is visible as a vertical line in the progress box above the screen. The trigger polarity can be changed by clicking the button just below the trigger level display.

Now that we have adjusted the vertical controls and triggering, the scope display looks something like the following figure.

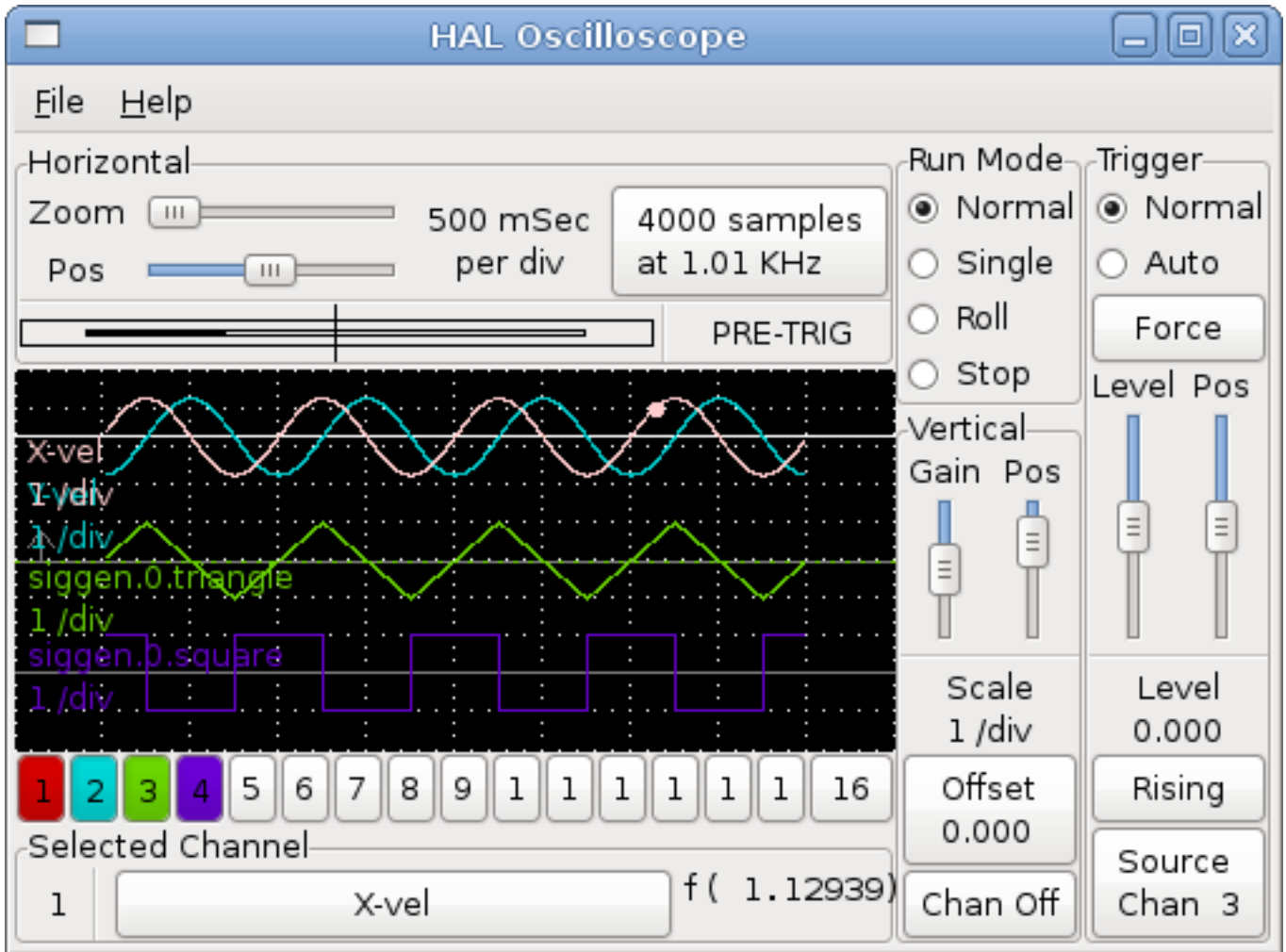

Figure 2.11: Waveforms with Triggering

2.5.5 Horizontal Adjustments

To look closely at part of a waveform, you can use the zoom slider at the top of the screen to expand the waveforms horizontally, and the position slider to determine which part of the zoomed waveform is visible. However, sometimes simply expanding the waveforms isn't enough and you need to increase the sampling rate. For example, we would like to look at the actual step pulses that are being generated in our example. Since the step pulses may be only 50 us long, sampling at 1KHz isn't fast enough. To change the sample rate, click on the button that displays the number of samples and sample rate to bring up the *Select Sample Rate* dialog, figure . For this example, we will click on the 50 us thread, *fast*, which gives us a sample rate of about 20KHz. Now instead of displaying about 4 seconds worth of data, one record is 4000 samples at 20KHz, or about 0.20 seconds.

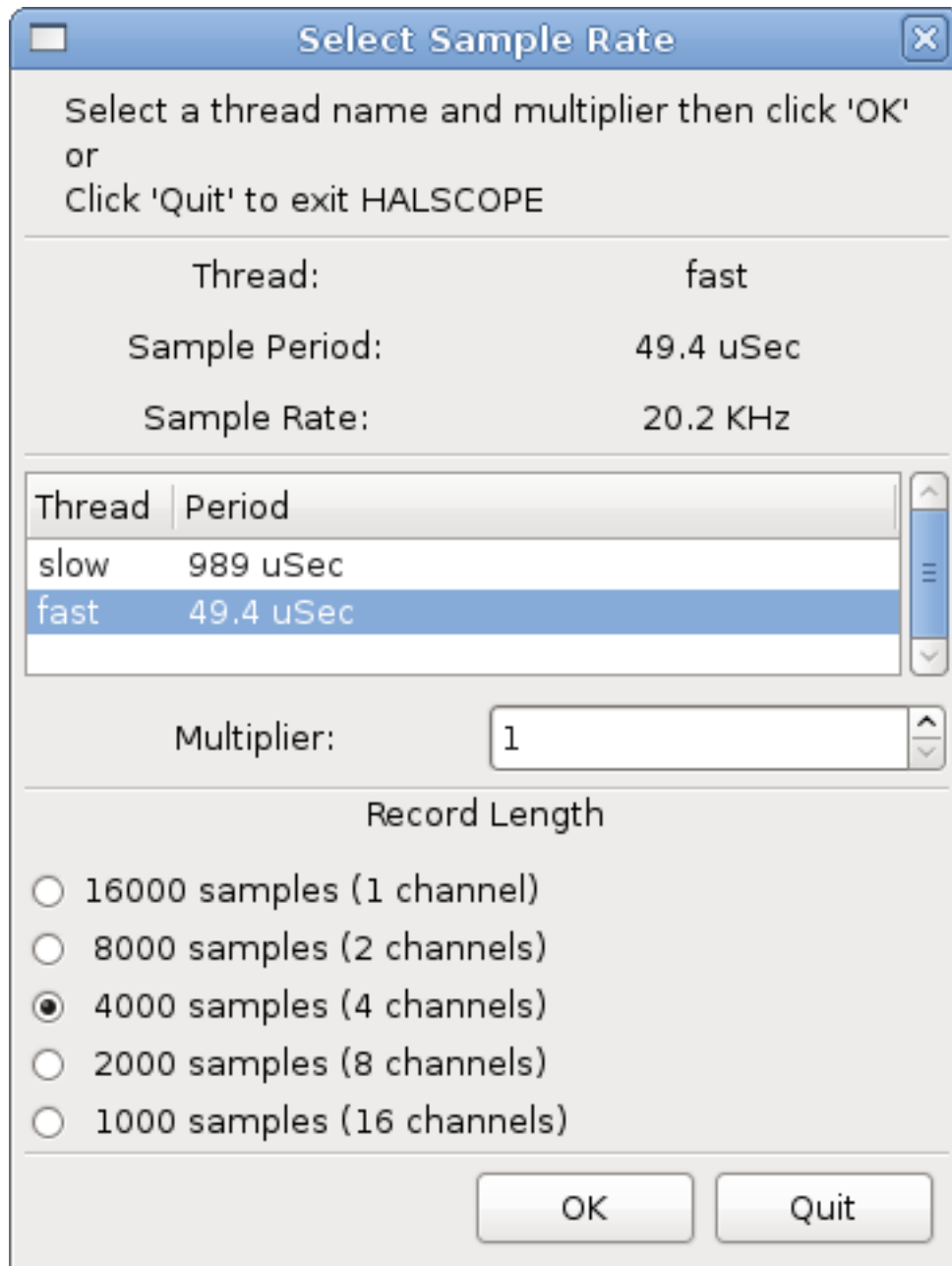

Figure 2.12: Sample Rate Dialog

2.5.6 More Channels

Now let's look at the step pulses. Halscope has 16 channels, but for this example we are using only 4 at a time. Before we select any more channels, we need to turn off a couple. Click on the channel 2 button, then click the *Chan Off* button at the bottom of the *Vertical* box. Then click on channel 3, turn it off, and do the same for channel 4. Even though the channels are turned off, they still remember what they are connected to, and in fact we will continue to use channel 3 as the trigger source. To add new channels, select channel 5, and choose pin *stepgen.0.dir*, then channel 6, and select *stepgen.0.step*. Then click run mode *Normal* to start the scope, and adjust the horizontal zoom to 5 ms per division. You should see the step pulses slow down as the velocity command (channel 1) approaches zero, then the direction pin changes state and the step pulses speed up again. You might want to increase the gain on channel 1 to about 20 milli per division to better see the change in the velocity command. The result should look like the following figure.

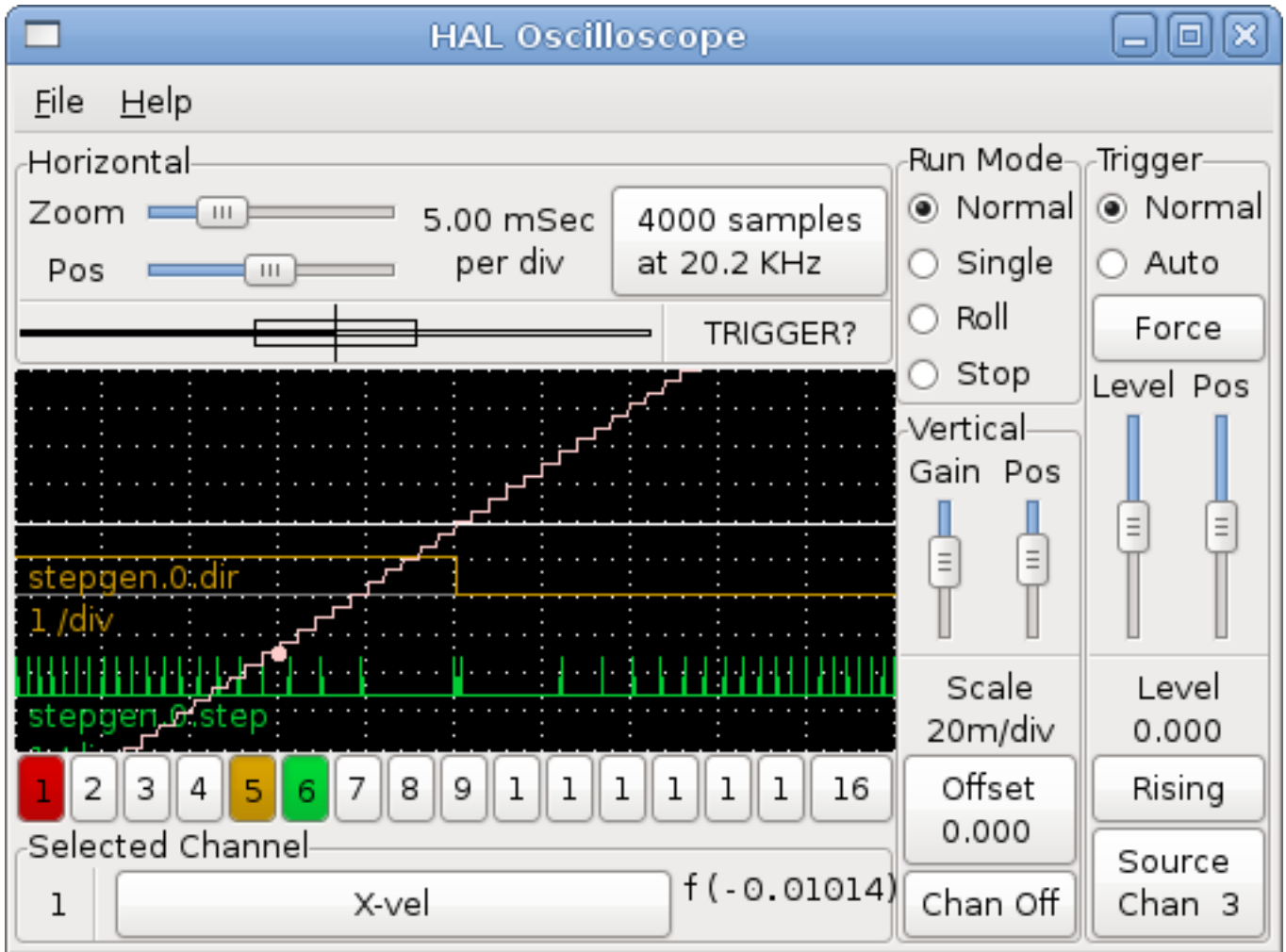

Figure 2.13: Step Pulses

2.5.7 More samples

If you want to record more samples at once, restart realtime and load halscope with a numeric argument which indicates the number of samples you want to capture.

```
halcmd: loadusr halscope 80000
```

If the *scope_rt* component was not already loaded, halscope will load it and request 80000 total samples, so that when sampling 4 channels at a time there will be 20000 samples per channel. (If *scope_rt* was already loaded, the numeric argument to halscope will have no effect).

Chapter 3

General Reference

3.1 General Naming Conventions

Consistent naming conventions would make HAL much easier to use. For example, if every encoder driver provided the same set of pins and named them the same way it would be easy to change from one type of encoder driver to another. Unfortunately, like many open-source projects, HAL is a combination of things that were designed, and things that simply evolved. As a result, there are many inconsistencies. This section attempts to address that problem by defining some conventions, but it will probably be a while before all the modules are converted to follow them.

Halcmd and other low-level HAL utilities treat HAL names as single entities, with no internal structure. However, most modules do have some implicit structure. For example, a board provides several functional blocks, each block might have several channels, and each channel has one or more pins. This results in a structure that resembles a directory tree. Even though halcmd doesn't recognize the tree structure, proper choice of naming conventions will let it group related items together (since it sorts the names). In addition, higher level tools can be designed to recognize such structure, if the names provide the necessary information. To do that, all HAL components should follow these rules:

- Dots (“.”) separate levels of the hierarchy. This is analogous to the slash (“/”) in a filename.
- Hyphens (“-”) separate words or fields in the same level of the hierarchy.
- HAL components should not use underscores or “MixedCase”.
- Use only lowercase letters and numbers in names.

3.2 Hardware Driver Naming Conventions

3.2.1 Pin/Parameter names

Hardware drivers should use five fields (on three levels) to make up a pin or parameter name, as follows:

```
<device-name>.<device-num>.<io-type>.<chan-num>.<specific-name>
```

The individual fields are:

<device-name>

The device that the driver is intended to work with. This is most often an interface board of some type, but there are other possibilities.

<device-num>

It is possible to install more than one servo board, parallel port, or other hardware device in a computer. The device number identifies a specific device. Device numbers start at 0 and increment.

<io-type>

Most devices provide more than one type of I/O. Even the simple parallel port has both digital inputs and digital outputs. More complex boards can have digital inputs and outputs, encoder counters, pwm or step pulse generators, analog-to-digital converters, digital-to-analog converters, or other unique capabilities. The I/O type is used to identify the kind of I/O that a pin or parameter is associated with. Ideally, drivers that implement the same I/O type, even if for very different devices, should provide a consistent set of pins and parameters and identical behavior. For example, all digital inputs should behave the same when seen from inside the HAL, regardless of the device.

<chan-num>

Virtually every I/O device has multiple channels, and the channel number identifies one of them. Like device numbers, channel numbers start at zero and increment.¹ If more than one device is installed, the channel numbers on additional devices start over at zero. If it is possible to have a channel number greater than 9, then channel numbers should be two digits, with a leading zero on numbers less than 10 to preserve sort ordering. Some modules have pins and/or parameters that affect more than one channel. For example a PWM generator might have four channels with four independent “duty-cycle” inputs, but one “frequency” parameter that controls all four channels (due to hardware limitations). The frequency parameter should use “0-3” as the channel number.

<specific-name>

An individual I/O channel might have just a single HAL pin associated with it, but most have more than one. For example, a digital input has two pins, one is the state of the physical pin, the other is the same thing inverted. That allows the configurator to choose between active high and active low inputs. For most io-types, there is a standard set of pins and parameters, (referred to as the “canonical interface”) that the driver should implement. The canonical interfaces are described in the [Canonical Device Interfaces](#) chapter.

EXAMPLES

motenc.0.encoder.2.position

— the position output of the third encoder channel on the first Motenc board.

stg.0.din.03.in

— the state of the fourth digital input on the first Servo-to-Go board.

ppmc.0.pwm.00-03.frequency

— the carrier frequency used for PWM channels 0 through 3 on the first Pico Systems ppmc board.

3.2.2 Function Names

Hardware drivers usually only have two kinds of HAL functions, ones that read the hardware and update HAL pins, and ones that write to the hardware using data from HAL pins. They should be named as follows:

<device-name>-<device-num>.<io-type>-<chan-num-range>.read|write

<device-name>

The same as used for pins and parameters.

<device-num>

The specific device that the function will access.

<io-type>

Optional. A function may access all of the I/O on a board, or it may access only a certain type. For example, there may be independent functions for reading encoder counters and reading digital I/O. If such independent functions exist, the <io-type> field identifies the type of I/O they access. If a single function reads all I/O provided by the board, <io-type> is not used.²

¹ One exception to the “channel numbers start at zero” rule is the parallel port. Its HAL pins are numbered with the corresponding pin number on the DB-25 connector. This is convenient for wiring, but inconsistent with other drivers. There is some debate over whether this is a bug or a feature.

² Note to driver programmers: do NOT implement separate functions for different I/O types unless they are interruptible and can work in independent threads. If interrupting an encoder read, reading digital inputs, and then resuming the encoder read will cause problems, then implement a single function that does everything.

<chan-num-range>

Optional. Used only if the <io-type> I/O is broken into groups and accessed by different functions.

read|write

Indicates whether the function reads the hardware or writes to it.

EXAMPLES

motenc.0.encoder.read

— reads all encoders on the first motenc board.

generic8255.0.din.09-15.read

— reads the second 8 bit port on the first generic 8255 based digital I/O board.

ppmc.0.write

— writes all outputs (step generators, pwm, DACs, and digital) on the first Pico Systems ppmc board.

Chapter 4

Canonical Device Interfaces

Note

By version 2.1, the HAL drivers should have all been updated to match these specs. Send an email if you spot any problems.

4.1 Introduction

The following sections show the pins, parameters, and functions that are supplied by “canonical devices”. All HAL device drivers should supply the same pins and parameters, and implement the same behavior.

Note that the only the `<io-type>` and `<specific-name>` fields are defined for a canonical device. The `<device-name>`, `<device-num>`, and `<chan-num>` fields are set based on the characteristics of the real device.

4.2 Digital Input

The canonical digital input (I/O type field: `digin`) is quite simple.

4.2.1 Pins

- (bit) **in** — State of the hardware input.
- (bit) **in-not** — Inverted state of the input.

4.2.2 Parameters

- None

4.2.3 Functions

- (funct) **read** — Read hardware and set `in` and `in-not` HAL pins.

4.3 Digital Output

The canonical digital output (I/O type field: `digout`) is also very simple.

4.3.1 Pins

- (bit) **out** — Value to be written (possibly inverted) to the hardware output.

4.3.2 Parameters

- (bit) **invert** — If TRUE, **out** is inverted before writing to the hardware.

4.3.3 Functions

- (funct) **write** — Read **out** and **invert**, and set hardware output accordingly.

4.4 Analog Input

The canonical analog input (I/O type: `adcin`). This is expected to be used for analog to digital converters, which convert e.g. voltage to a continuous range of values.

4.4.1 Pins

- (float) **value** — The hardware reading, scaled according to the **scale** and **offset** parameters. **Value** = ((input reading, in hardware-dependent units) * **scale**) - **offset**

4.4.2 Parameters

- (float) **scale** — The input voltage (or current) will be multiplied by **scale** before being output to **value**.
- (float) **offset** — This will be subtracted from the hardware input voltage (or current) after the scale multiplier has been applied.
- (float) **bit_weight** — The value of one least significant bit (LSB). This is effectively the granularity of the input reading.
- (float) **hw_offset** — The value present on the input when 0 volts is applied to the input pin(s).

4.4.3 Functions

- (funct) **read** — Read the values of this analog input channel. This may be used for individual channel reads, or it may cause all channels to be read

4.5 Analog Output

The canonical analog output (I/O Type: `adcout`). This is intended for any kind of hardware that can output a more-or-less continuous range of values. Examples are digital to analog converters or PWM generators.

4.5.1 Pins

- (float) **value** — The value to be written. The actual value output to the hardware will depend on the scale and offset parameters.
 - (bit) **enable** — If false, then output 0 to the hardware, regardless of the **value** pin.
-

4.5.2 Parameters

- (float) **offset** — This will be added to the **value** before the hardware is updated
- (float) **scale** — This should be set so that an input of 1 on the **value** pin will cause the analog output pin to read 1 volt.
- (float) **high_limit** (optional) — When calculating the value to output to the hardware, if **value + offset** is greater than **high_limit**, then **high_limit** will be used instead.
- (float) **low_limit** (optional) — When calculating the value to output to the hardware, if **value + offset** is less than **low_limit**, then **low_limit** will be used instead.
- (float) **bit_weight** (optional) — The value of one least significant bit (LSB), in volts (or mA, for current outputs)
- (float) **hw_offset** (optional) — The actual voltage (or current) that will be output if 0 is written to the hardware.

4.5.3 Functions

(funct) **write** — This causes the calculated value to be output to the hardware. If **enable** is false, then the output will be 0, regardless of **value**, **scale**, and **offset**. The meaning of “0” is dependent on the hardware. For example, a bipolar 12-bit A/D may need to write 0x1FF (mid scale) to the D/A get 0 volts from the hardware pin. If **enable** is true, read **scale**, **offset** and **value** and output to the adc (**scale * value**) + **offset**. If **enable** is false, then output 0.

Chapter 5

HAL Tools

5.1 Halcmd

Halcmd is a command line tool for manipulating the HAL. There is a rather complete man page for halcmd, which will be installed if you have installed LinuxCNC from either source or a package. If you have compiled LinuxCNC for “run-in-place”, the man page is not installed, but it is accessible. From the main LinuxCNC directory, do:

```
man -M docs/man halcmd
```

The [HAL Tutorial](#) has a number of examples of halcmd usage, and is a good tutorial for halcmd.

5.2 Halmeter

Halmeter is a *voltmeter* for the HAL. It lets you look at a pin, signal, or parameter, and displays the current value of that item. It is pretty simple to use. Start it by typing **halmeter** in an X windows shell. Halmeter is a GUI application. It will pop up a small window, with two buttons labeled *Select* and *Exit*. Exit is easy - it shuts down the program. Select pops up a larger window, with three tabs. One tab lists all the pins currently defined in the HAL. The next lists all the signals, and the last tab lists all the parameters. Click on a tab, then click on a pin/signal/parameter. Then click on *OK*. The lists will disappear, and the small window will display the name and value of the selected item. The display is updated approximately 10 times per second. If you click *Accept* instead of *OK*, the small window will display the name and value of the selected item, but the large window will remain on the screen. This is convenient if you want to look at a number of different items quickly.

You can have many halmeters running at the same time, if you want to monitor several items. If you want to launch a halmeter without tying up a shell window, type *halmeter &* to run it in the background. You can also make halmeter start displaying a specific item immediately, by adding *pin|sig|par[am] <name>* to the command line. It will display the pin, signal, or parameter <name> as soon as it starts. (If there is no such item, it will simply start normally.) And finally, if you specify an item to display, you can add *-s* before the pin|sig|param to tell halmeter to use a small window. The item name will be displayed in the title bar instead of under the value, and there will be no buttons. Useful when you want a lot of meters in a small amount of screen space.

Refer to [Halmeter Tutorial](#) section for more information.

Halmeter can be loaded from a terminal or from Axis. Halmeter is faster than Halshow at displaying values. Halmeter has two windows, one to pick the pin, signal, or parameter to monitor and one that displays the value. Multiple Halmeters can be open at the same time. If you use a script to open multiple Halmeters you can set the position of each one with *-g X Y* relative to the upper left corner of your screen. For example:

```
loadusr halmeter pin hm2.0.stepgen.00.velocity-fb -g 0 500
```

See the man page for more options. See section [Halmeter](#).

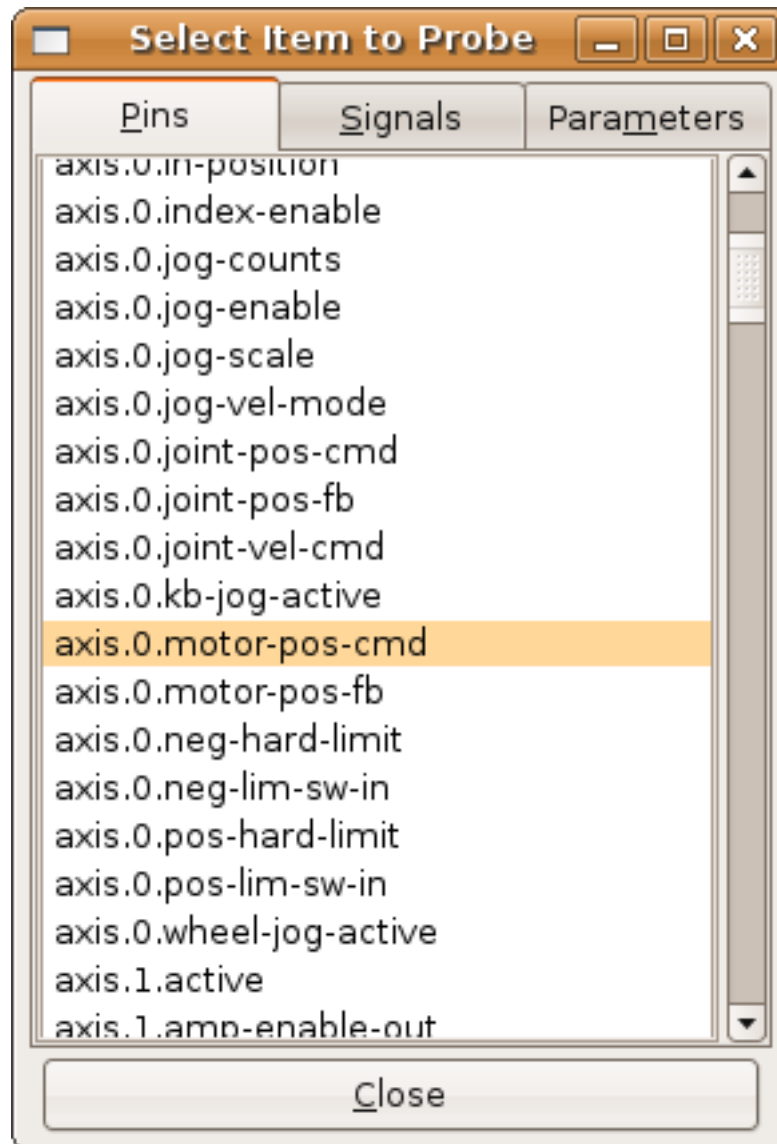
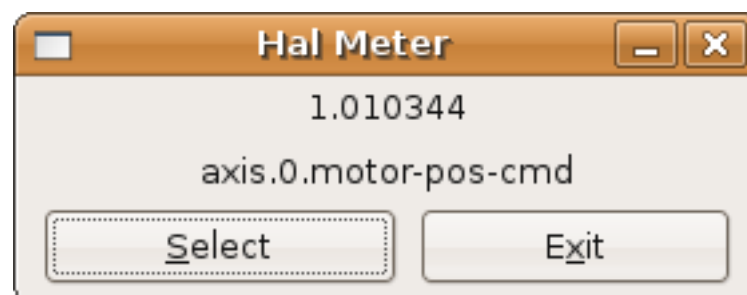

Figure 5.1: Halmeter



5.3 Halscope

Halscope is an *oscilloscope* for the HAL. It lets you capture the value of pins, signals, and parameters as a function of time. Complete operating instructions should be located here eventually. For now, refer to section [\[sec:Tutorial-Halscope\]](#) in the tutorial chapter, which explains the basics.

Chapter 6

Basic HAL Tutorial

6.1 HAL Commands

More detailed information can be found in the man page for halcmd *man halcmd* in a terminal window. To see the HAL configuration and check the status of pins and parameters use the HAL Configuration window on the Machine menu in AXIS. To watch a pin status open the Watch tab and click on each pin you wish to watch and it will be added to the watch window.

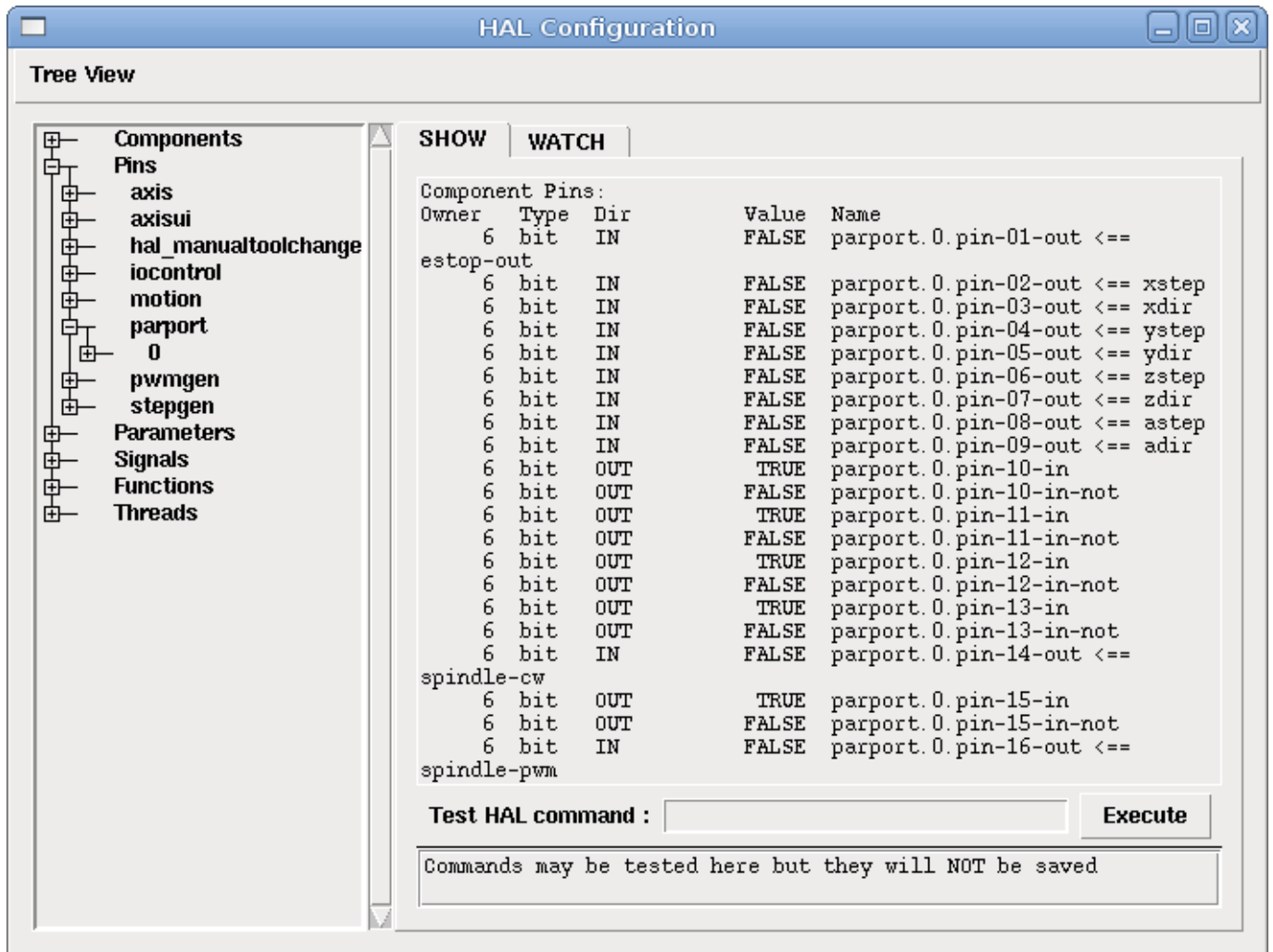

Figure 6.1: HAL Configuration Window

6.1.1 loadrt

The command *loadrt* loads a real time HAL component. Real time component functions need to be added to a thread to be updated at the rate of the thread. You cannot load a user space component into the real time space.

The syntax and an example:

```
loadrt <component> <options>
```

```
loadrt mux4 count=1
```

6.1.2 addf

The command *addf* adds a real time component function to a thread. You have to add a function from a HAL real time component to a thread to get the function to update at the rate of the thread.

If you used the Stepper Config Wizard to generate your config you will have two threads.

- base-thread (the high-speed thread): this thread handles items that need a fast response, like making step pulses, and reading and writing the parallel port.

- `servo-thread` (the slow-speed thread): this thread handles items that can tolerate a slower response, like the motion controller, `ClassicLadder`, and the motion command handler.

The syntax and an example:

```
addf <component> <thread>
addf mux4 servo-thread
```

6.1.3 loadusr

The command `loadusr` loads a user space HAL component. User space programs are their own separate processes, which optionally talk to other HAL components via pins and parameters. You cannot load real time components into user space.

Flags may be one or more of the following:

- W to wait for the component to become ready. The component is assumed to have the same name as the first argument of the command.
- Wn <name> to wait for the component, which will have the given <name>. This only applies if the component has a name option.
- w to wait for the program to exit
- i to ignore the program return value (with -w)
- n name a component when it is a valid option for that component.

The syntax and examples:

```
loadusr <component> <options>
loadusr halui
loadusr -Wn spindle gs2_vfd -n spindle
```

In English it means *loadusr wait for name spindle component gs2_vfd name spindle*.

6.1.4 net

The command `net` creates a *connection* between a signal and one or more pins. If the signal does not exist `net` creates the new signal. This replaces the need to use the command `newsig`. The optional direction arrows `<=`, `=>` and `<=>` make it easier to follow the logic when reading a `net` command line and are not used by the `net` command. The direction arrows must be separated by a space from the pin names.

Syntax and Example:

```
net signal-name pin-name <optional arrow> <optional second pin-name>
net home-x axis.0.home-sw-in <= parport.0.pin-11-in
```

In the above example `home-x` is the signal name, `axis.0.home-sw-in` is a *Direction IN* pin, `<=` is the optional direction arrow, and `parport.0.pin-11-in` is a *Direction OUT* pin. This may seem confusing but the in and out labels for a parallel port pin indicates the physical way the pin works not how it is handled in HAL.

A pin can be connected to a signal if it obeys the following rules:

- An IN pin can always be connected to a signal
- An IO pin can be connected unless there's an OUT pin on the signal
- An OUT pin can be connected only if there are no other OUT or IO pins on the signal

The same *signal-name* can be used in multiple net commands to connect additional pins, as long as the rules above are obeyed.

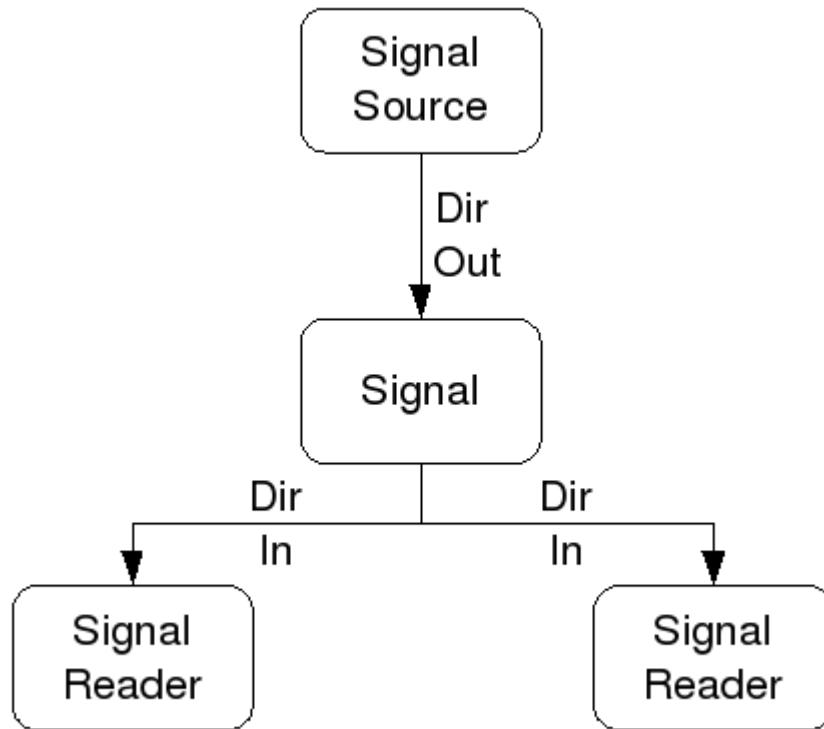

Figure 6.2: Signal Direction

This example shows the signal `xStep` with the source being `stepgen.0.out` and with two readers, `parport.0.pin-02-out` and `parport.0.pin-08-out`. Basically the value of `stepgen.0.out` is sent to the signal `xStep` and that value is then sent to `parport.0.pin-02-out` and `parport.0.pin-08-out`.

```
# signal source destination destination
net xStep stepgen.0.out => parport.0.pin-02-out parport.0.pin-08-out
```

Since the signal `xStep` contains the value of `stepgen.0.out` (the source) you can use the same signal again to send the value to another reader. To do this just use the signal with the readers on another line.

```
net xStep => parport.0.pin-02-out
```

I/O pins An I/O pin like `encoder.N.index-enable` can be read or set as allowed by the component.

6.1.5 setp

The command `setp` sets the value of a pin or parameter. The valid values will depend on the type of the pin or parameter. It is an error if the data types do not match.

Some components have parameters that need to be set before use. Parameters can be set before use or while running as needed. You cannot use `setp` on a pin that is connected to a signal.

The syntax and an example:

```
setp <pin/parameter-name> <value>

setp parport.0.pin-08-out TRUE
```

6.1.6 sets

The command `sets` sets the value of a signal.

The syntax and an example:

```
sets <signal-name> <value>

net mysignal and2.0.in0 pyvcp.my-led

sets mysignal 1
```

It is an error if:

- The signal-name does not exist
- If the signal already has a writer
- If value is not the correct type for the signal

6.1.7 unlinkp

The command `unlinkp` unlinks a pin from the connected signal. If no signal was connected to the pin prior running the command, nothing happens. The `unlinkp` command is useful for trouble shooting.

The syntax and an example:

```
unlinkp <pin-name>

unlinkp parport.0.pin-02-out
```

6.1.8 Obsolete Commands

The following commands are depreciated and may be removed from future versions. Any new configuration should use the `net` command. These commands are included so older configurations will still work.

6.1.8.1 linksp

The command `linksp` creates a *connection* between a signal and one pin.

The syntax and an example:

```
linksp <signal-name> <pin-name>
linksp X-step parport.0.pin-02-out
```

The `linksp` command has been superseded by the `net` command.

6.1.8.2 linkps

The command *linkps* creates a *connection* between one pin and one signal. It is the same as *linksp* but the arguments are reversed.

The syntax and an example:

```
linkps <pin-name> <signal-name>
linkps parport.0.pin-02-out X-Step
```

The *linkps* command has been superseded by the *net* command.

6.1.8.3 newsig

the command *newsig* creates a new HAL signal by the name <signame> and the data type of <type>. Type must be *bit*, *s32*, *u32* or *float*. Error if <signame> all ready exists.

The syntax and an example:

```
newsig <signame> <type>
newsig Xstep bit
```

More information can be found in the HAL manual or the man pages for *halrun*.

6.2 HAL Data

6.2.1 Bit

A bit value is an on or off.

- bit values = true or 1 and false or 0 (True, TRUE, true are all valid)

6.2.2 Float

A *float* is a floating point number. In other words the decimal point can move as needed.

- float values = a 64 bit floating point value, with approximately 53 bits of resolution and over 1000 bits of dynamic range.

For more information on floating point numbers see:

http://en.wikipedia.org/wiki/Floating_point

6.2.3 s32

An *s32* number is a whole number that can have a negative or positive value.

- s32 values = integer numbers -2147483648 to 2147483647

6.2.4 u32

A *u32* number is a whole number that is positive only.

- u32 values = integer numbers 0 to 4294967295
-

6.3 HAL Files

If you used the Stepper Config Wizard to generate your config you will have up to three HAL files in your config directory.

- `my-mill.hal` (if your config is named *my-mill*) This file is loaded first and should not be changed if you used the Stepper Config Wizard.
- `custom.hal` This file is loaded next and before the GUI loads. This is where you put your custom HAL commands that you want loaded before the GUI is loaded.
- `custom_postgui.hal` This file is loaded after the GUI loads. This is where you put your custom HAL commands that you want loaded after the GUI is loaded. Any HAL commands that use pyVCP widgets need to be placed here.

6.4 HAL Components

Two parameters are automatically added to each HAL component when it is created. These parameters allow you to scope the execution time of a component.

```
.time
```

```
.tmax
```

Time is the number of CPU cycles it took to execute the function.

Tmax is the maximum number of CPU cycles it took to execute the function. Tmax is a read/write parameter so the user can set it to 0 to get rid of the first time initialization on the function's execution time.

6.5 Logic Components

HAL contains several real time logic components. Logic components follow a *Truth Table* that states what the output is for any given input. Typically these are bit manipulators and follow electrical logic gate truth tables.

6.5.1 and2

The *and2* component is a two input *and* gate. The truth table below shows the output based on each combination of input.

Syntax

```
and2 [count=N] | [names=name1[,name2...]]
```

Functions

`and2.n`

Pins

```
and2.N.in0 (bit, in)
and2.N.in1 (bit, in)
and2.N.out (bit, out)
```

Truth Table

in0	in1	out
False	False	False
True	False	False
False	True	False
True	True	True

6.5.2 not

The *not* component is a bit inverter.

Syntax

```
not [count=n] | [names=name1[,name2...]]
```

Functions

```
not.all
not.n
```

Pins

```
not.n.in (bit, in)
not.n.out (bit, out)
```

Truth Table

in	out
True	False
False	True

6.5.3 or2

The *or2* component is a two input OR gate.

Syntax

```
or2[count=n] | [names=name1[,name2...]]
```

Functions

```
or2.n
```

Pins

```
or2.n.in0 (bit, in)
or2.n.in1 (bit, in)
or2.n.out (bit, out)
```

Truth Table

in0	in1	out
True	False	True
True	True	True
False	True	True
False	False	False

6.5.4 xor2

The *xor2* component is a two input XOR (exclusive OR)gate.

Syntax

```
xor2[count=n] | [names=name1[,name2...]]
```

Functions

xor2.n

Pins

xor2.n.in0 (bit, in)
 xor2.n.in1 (bit, in)
 xor2.n.out (bit, out)

Truth Table

in0	in1	out
True	False	True
True	True	False
False	True	True
False	False	False

6.5.5 Logic Examples

An *and2* example connecting two inputs to one output.

```
loadrt and2 count=1

addf and2.0 servo-thread

net my-sigin1 and2.0.in0 <= parport.0.pin-11-in
net my-sigin2 and2.0.in1 <= parport.0.pin-12-in
net both-on parport.0.pin-14-out <= and2.0.out
```

In the above example one copy of *and2* is loaded into real time space and added to the servo thread. Next pin 11 of the parallel port is connected to the *in0* bit of the *and* gate. Next pin 12 is connected to the *in1* bit of the *and* gate. Last we connect the *and2* out bit to the parallel port pin 14. So following the truth table for *and2* if pin 11 and pin 12 are on then the output pin 14 will be on.

6.6 Conversion Components

6.6.1 weighted_sum

The *weighted_sum* converts a group of bits to an integer. The conversion is the sum of the *weights* of the bits that are on plus any offset. The weight of the *m*-th bit is 2^m . This is similar to a binary coded decimal but with more options. The *hold* bit stops processing the input changes so the *sum* will not change.

The following syntax is used to load the *weighted_sum* component.

```
loadrt weighted_sum wsum_sizes=size[,size,...]
```

Creates weighted sum groups each with the given number of input bits (*size*).

To update the *weighted_sum* you need to attach *process_wsums* to a thread.

```
addf process_wsums servo-thread
```

This updates the *weighted_sum* component.

In the following example clipped from the HAL Configuration window in Axis the bits 0 and 2 are true and there is no offset. The *weight* of 0 is 1 and the *weight* of 2 is 4 so the sum is 5.

weighted_sum

Component Pins:

Owner	Type	Dir	Value	Name
10	bit	In	TRUE	wsum.0.bit.0.in
10	s32	I/O	1	wsum.0.bit.0.weight
10	bit	In	FALSE	wsum.0.bit.1.in
10	s32	I/O	2	wsum.0.bit.1.weight
10	bit	In	TRUE	wsum.0.bit.2.in
10	s32	I/O	4	wsum.0.bit.2.weight
10	bit	In	FALSE	wsum.0.bit.3.in
10	s32	I/O	8	wsum.0.bit.3.weight
10	bit	In	FALSE	wsum.0.hold
10	s32	I/O	0	wsum.0.offset
10	s32	Out	5	wsum.0.sum

Chapter 7

Halshow

The script `halshow` can help you find your way around a running HAL. This is a very specialized system and it must connect to a working HAL. It cannot run standalone because it relies on the ability of HAL to report what it knows of itself through the `halcmd` interface library. It is discovery based. Each time `halshow` runs with a different LinuxCNC configuration it will be different.

As we will soon see, this ability of HAL to document itself is one key to making an effective CNC system.

7.1 Starting Halshow

Halshow is in the AXIS menu under Machine/Show HAL Configuration.

Halshow is in the TkLinuxCNC menu under Scripts/HAL Show.

7.2 HAL Tree Area

At the left of its display as shown in figure [\[cap:Halshow-Layout\]](#) is a tree view, somewhat like you might see with some file browsers. At the right is a tabbed notebook with tabs for show and watch.

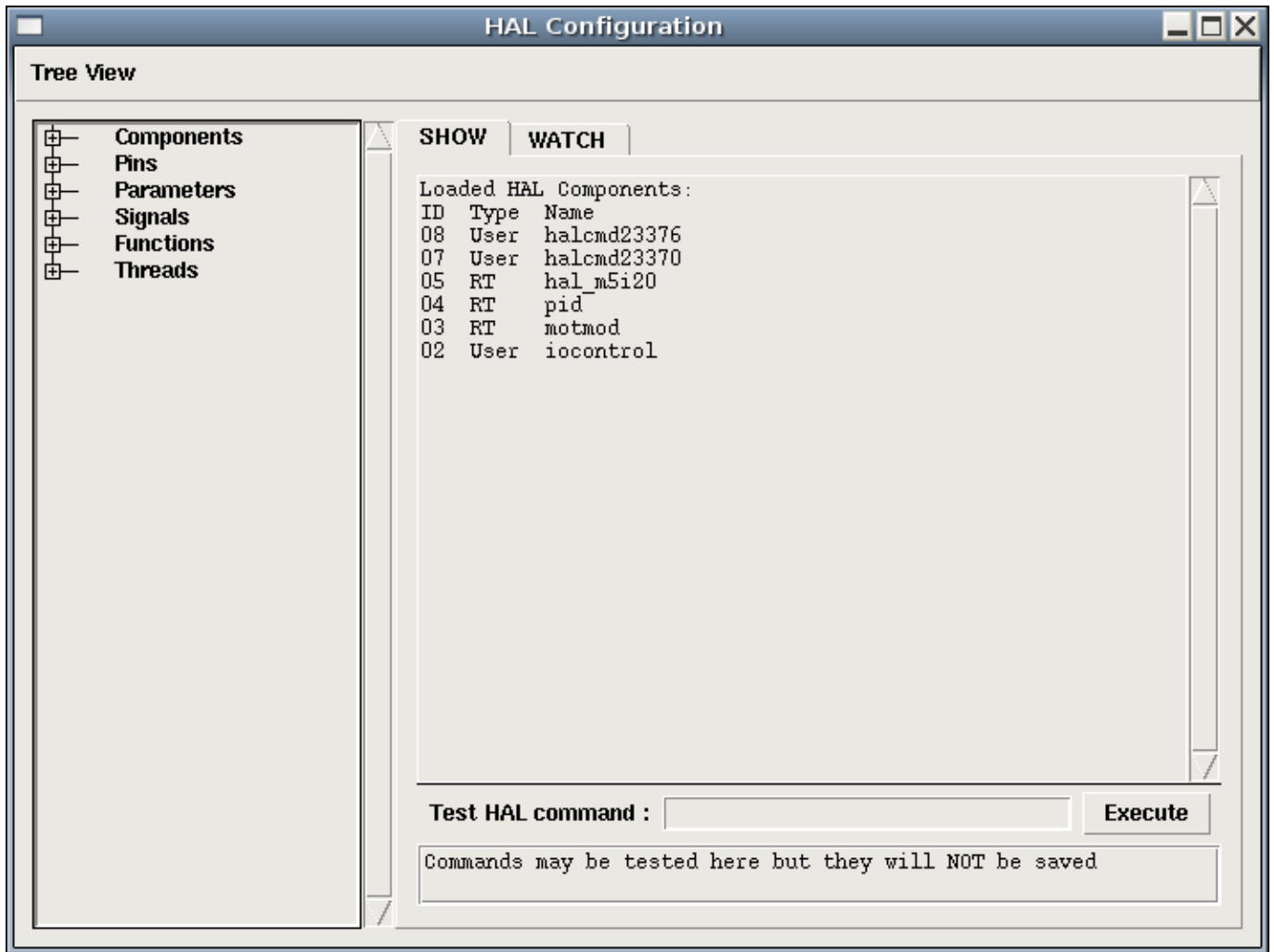

Figure 7.1: Halshow Layout

The tree shows all of the major parts of a HAL. In front of each is a small plus (+) or minus (-) sign in a box. Clicking the plus will expand that tree node to display what is under it. If that box shows a minus sign, clicking it will collapse that section of the tree.

You can also expand or collapse the tree display using the Tree View menu at the upper left edge of the display. Under Tree View you will find: Expand Tree, Collapse Tree; Expand Pins, Expand Parameters, Expand Signals; and Erase Watch. (Note that Erase Watch erases *all* previously set watches, you cannot erase just one watch.)

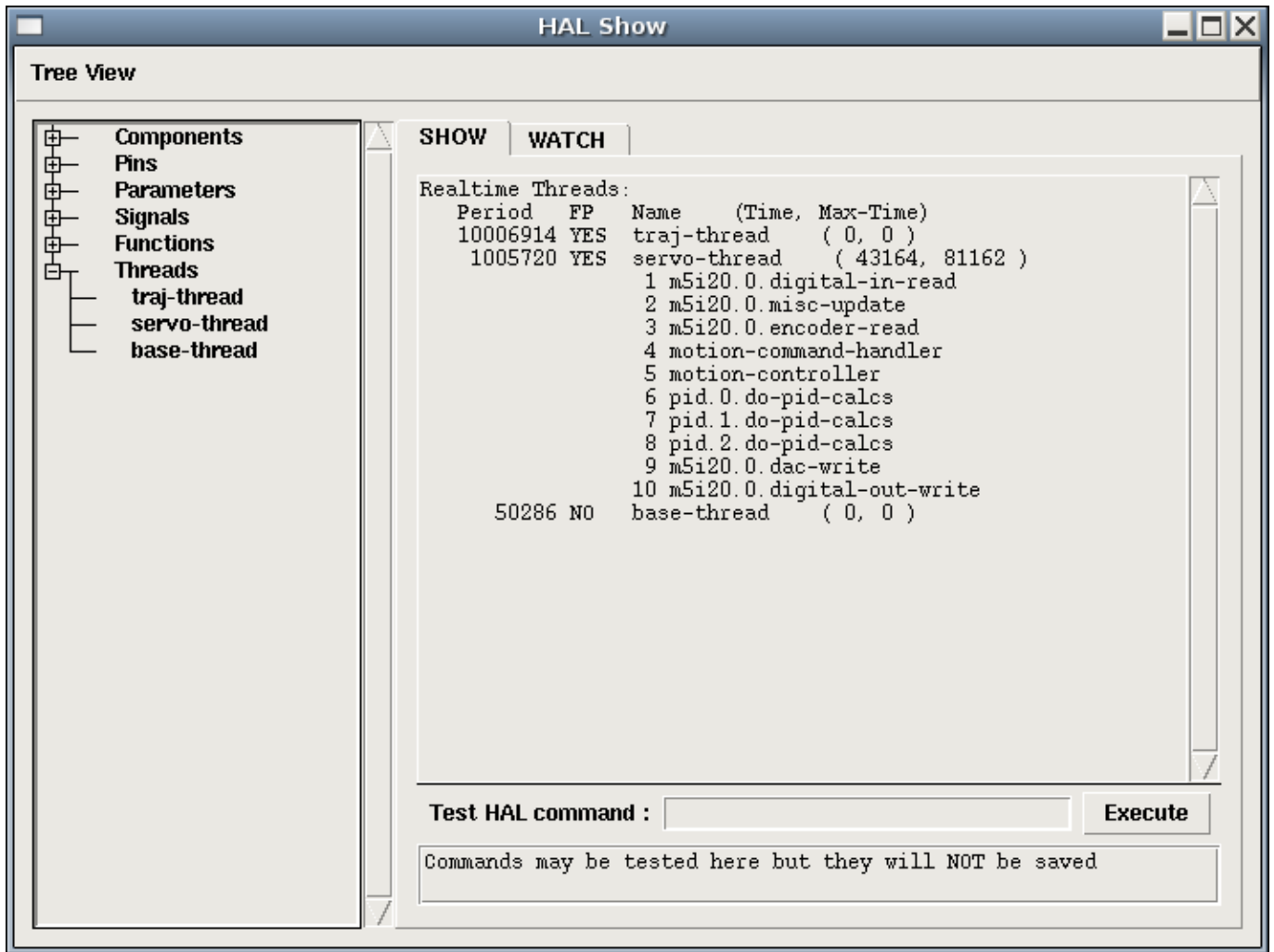

Figure 7.2: Show Menu

7.3 HAL Show Area

Clicking on the node name, the word "Components" for example, will show you (under the "Show" tab) all that HAL knows about the contents of that node. Figure [cap:Halshow-Layout] shows a list exactly like you will see if you click the "Components" name while you are running a standard m5i20 servo card. The information display is exactly like those shown in traditional text based HAL analysis tools. The advantage here is that we have mouse click access, access that can be as broad or as focused as you need.

If we take a closer look at the tree display we can see that the six major parts of a HAL can all be expanded at least one level. As these levels are expanded you can get more focused with the reply when you click on the rightmost tree node. You will find that there are some HAL pins and parameters that show more than one reply. This is due to the nature of the search routines in halcmd itself. If you search one pin you may get two, like this:

```
Component Pins:
Owner  Type  Dir  Value  Name
06     bit   -W   TRUE   parport.0.pin-10-in
06     bit   -W   FALSE  parport.0.pin-10-in-not
```

The second pin's name contains the complete name of the first.

Below the show area on the right is a set of widgets that will allow you to play with the running HAL. The commands you enter here and the effect that they have on the running HAL are not saved. They will persist as long as LinuxCNC remains up but are gone as soon as LinuxCNC is.

The entry box labeled "Test HAL Command:" will accept any of the commands listed for halcmd. These include:

- loadrt, unloadrt (load/unload real-time module)
- loadusr, unloadusr (load/unload user-space component)
- addf, delf (add/delete a function to/from a real-time thread)
- net (create a connection between two or more items)
- setp (set parameter (or pin) to a value)

This little editor will enter a command any time you press <enter> or push the execute button. An error message from halcmd will show below this entry widget when these commands are not properly formed. If you are not certain how to set up a proper command you'll need to read again the documentation on halcmd and the specific modules that you are working with.

Let's use this editor to add a differential module to a HAL and connect it to axis position so that we could see the rate of change in position, i.e., acceleration. We first need to load a HAL component named blocks, add it to the servo thread, then connect it to the position pin of an axis. Once that is done we can find the output of the differentiator in halscope. So let's go. (Yes, I looked this one up.)

```
loadrt blocks ddt=1
```

Now look at the components node and you should see blocks in there someplace.

Loaded HAL Components:

ID	Type	Name
10	User	halcmd29800
09	User	halcmd29374
08	RT	blocks
06	RT	hal_parport
05	RT	scope_rt
04	RT	stepgen
03	RT	motmod
02	User	iocontrol

Sure enough there it is. Notice that its ID is 08. Next we need to find out what functions are available with it so we look at functions:

Exported Functions:

Owner	CodeAddr	Arg	FP	Users	Name
08	E0B97630	E0DC7674	YES	0	ddt.0
03	E0DEF83C	00000000	YES	1	motion-command-handler
03	E0DF0BF3	00000000	YES	1	motion-controller
06	E0B541FE	E0DC75B8	NO	1	parport.0.read
06	E0B54270	E0DC75B8	NO	1	parport.0.write
06	E0B54309	E0DC75B8	NO	0	parport.read-all
06	E0B5433A	E0DC75B8	NO	0	parport.write-all
05	E0AD712D	00000000	NO	0	scope.sample
04	E0B618C1	E0DC7448	YES	1	stepgen.capture-position
04	E0B612F5	E0DC7448	NO	1	stepgen.make-pulses
04	E0B614AD	E0DC7448	YES	1	stepgen.update-freq

Here we look for owner #08 and see that blocks has exported a function named ddt.0. We should be able to add ddt.0 to the servo thread and it will do its math each time the servo thread is updated. Once again we look up the addf command and find that it uses three arguments like this:

```
addf <funcname> <threadname> [<position>]
```

We already know the `funcname=ddt.0` so let's get the thread name right by expanding the thread node in the tree. Here we see two threads, `servo-thread` and `base-thread`. The position of `ddt.0` in the thread is not critical. So we add the function `ddt.0` to the `servo-thread`:

```
addf ddt.0 servo-thread
```

This is just for viewing, so we leave position blank and get the last position in the thread. Figure [cap:Addf-Command] shows the state of `halshow` after this command has been issued.

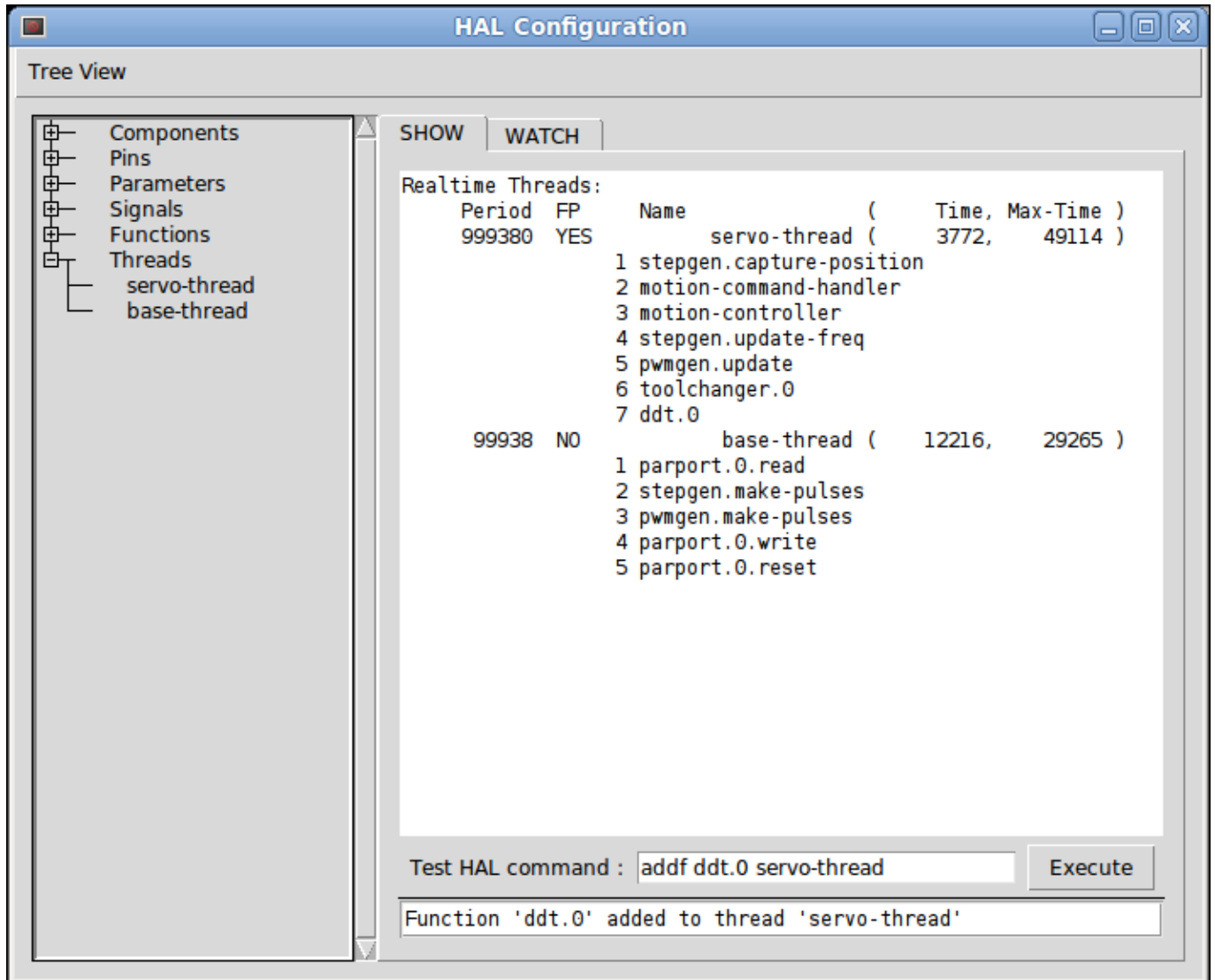

Figure 7.3: Addf Command

Next we need to connect this block to something. But how do we know what pins are available? The answer is to look under pins. There we find `ddt` and see this:

```
Component Pins:
Owner Type Dir Value Name
08 float R- 0.00000e+00 ddt.0.in
08 float -W 0.00000e+00 ddt.0.out
```

That looks easy enough to understand, but what signal or pin do we want to connect to it? It could be an axis pin, a stepgen pin, or a signal. We see this when we look at `axis.0`:

```
Component Pins:
Owner Type Dir Value Name
03 float -W 0.00000e+00 axis.0.motor-pos-cmd ==> Xpos-cmd
```

So it looks like Xpos-cmd should be a good signal to use. Back to the editor where we enter the following command:

```
linksp Xpos-cmd ddt.0.in
```

Now if we look at the Xpos-cmd signal using the tree node we'll see what we've done:

```
Signals:
Type Value Name
float 0.00000e+00 Xpos-cmd
<== axis.0.motor-pos-cmd
==> ddt.0.in
==> stepgen.0.position-cmd
```

We see that this signal comes from axis.o.motor-pos-cmd and goes to both ddt.0.in and stepgen.0.position-cmd. By connecting our block to the signal we have avoided any complications with the normal flow of this motion command.

The HAL Show Area uses halcmd to discover what is happening in a running HAL. It gives you complete information about what it has discovered. It also updates as you issue commands from the little editor panel to modify that HAL. There are times when you want a different set of things displayed without all of the information available in this area. That is where the HAL Watch Area is of value.

7.4 HAL Watch Area

Clicking the watch tab produces a blank canvas. You can add signals and pins to this canvas and watch their values.¹ You can add signals or pins when the watch tab is displayed by clicking on the name of it. Figure [cap:Watch-Display] shows this canvas with several "bit" type signals. These signals include enable-out for the first three axes and two of the three iocontrol "estop" signals. Notice that the axes are not enabled even though the estop signals say that LinuxCNC is not in estop. A quick look at TkLinuxCNC shows that the condition of LinuxCNC is ESTOP RESET. The amp enables do not turn true until the machine has been turned on.

¹ The refresh rate of the watch display is much lower than Halmeter or Halscope. If you need good resolution of the timing of signals those tools are much more effective.

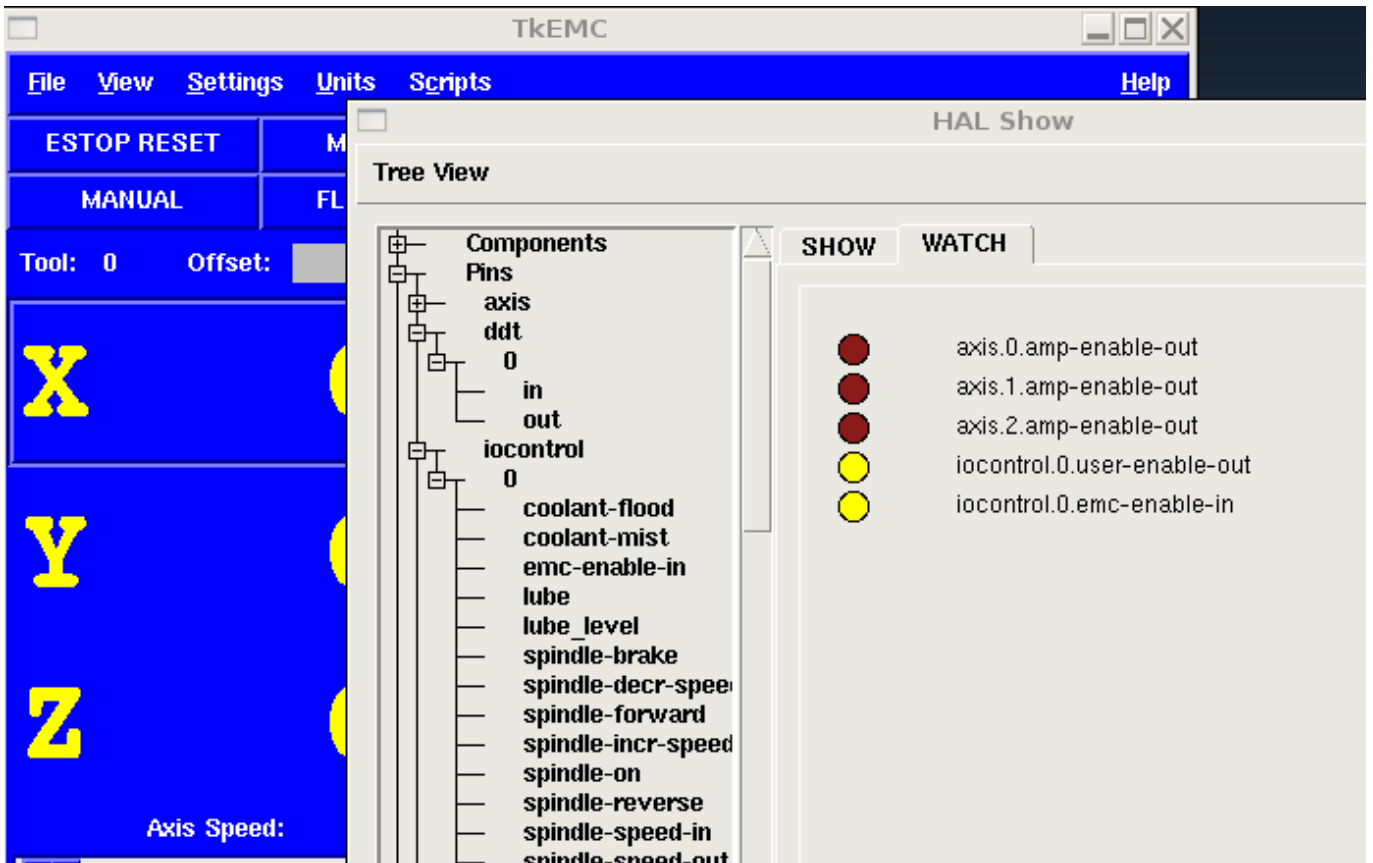

Figure 7.4: Watch Display

Watch displays bit type (binary) values using colored circles representing LEDs. They show as dark brown when a bit signal or pin is false, and as light yellow whenever that signal is true. If you select a pin or signal that is not a bit type (binary) signal, watch will show it as a numerical value.

Watch will quickly allow you to test switches or see the effect of changes that you make to LinuxCNC while using the graphical interface. Watch's refresh rate is a bit slow to see stepper pulses, but you can use it for these if you move an axis very slowly or in very small increments of distance. If you've used IO_Show in LinuxCNC, the watch page in halshow can be set up to watch a parport much as IO_Show did.

Chapter 8

HAL Components

8.1 Commands and Userspace Components

All of the commands in the following list have man pages. Some will have expanded descriptions, some will have limited descriptions. Also, all of the components listed below have man pages. From these two lists you know what components exist, and you can use *man n name* to get additional information. To view the information in the man page, in a terminal window type:

```
man axis (or perhaps 'man 1 axis' if your system requires it.)
```

axis

AXIS LinuxCNC (The Enhanced Machine Controller) Graphical User Interface.

axis-remote

AXIS Remote Interface.

comp

Build, compile and install LinuxCNC HAL components.

emc

LinuxCNC (The Enhanced Machine Controller).

gladevcp

Virtual Control Panel for LinuxCNC based on Glade, Gtk and HAL widgets.

gs2

HAL userspace component for Automation Direct GS2 VFD's.

halcmd

Manipulate the Enhanced Machine Controller HAL from the command line.

hal_input

Control HAL pins with any Linux input device, including USB HID devices.

halmeter

Observe HAL pins, signals, and parameters.

halrun

Manipulate the Enhanced Machine Controller HAL from the command line.

halsampler

Sample data from HAL in realtime.

halstreamer

Stream file data into HAL in real time.

halui

Observe HAL pins and command LinuxCNC through NML.

io

Accepts NML I/O commands, interacts with HAL in userspace.

iocontrol

Accepts NML I/O commands, interacts with HAL in userspace.

pyvcp

Virtual Control Panel for LinuxCNC.

shuttleexpress

control HAL pins with the ShuttleXpress device made by Contour Design.

8.2 Realtime Components List

Some of these will have expanded descriptions from the man pages. Some will have limited descriptions. All of the components have man pages. From this list you know what components exist and can use *man n name* to get additional information in a terminal window.

Note

If the component requires a floating point thread that is usually the slower servo-thread.

8.2.1 Core LinuxCNC components

motion

Accepts NML motion commands, interacts with HAL in realtime.

axis

Accepts NML motion commands, interacts with HAL in realtime.

classicladder

Realtime software PLC based on ladder logic. See Classic Ladder manual for more information.

gladevcp

Displays Virtual Control Panels built with GTK/Glade.

threads

Creates hard realtime HAL threads.

8.2.2 Logic and bitwise components

and2

Two-input AND gate. For out to be true both inputs must be true.

not

Inverter.

or2

Two-input OR gate.

xor2

Two-input XOR (exclusive OR) gate.

debounce

Filter noisy digital inputs. [Description](#)

edge

Edge detector.

flipflop

D type flip-flop.

oneshot

One-shot pulse generator.

logic

General logic function component.

lut5

A 5-input logic function based on a look-up table. [Description](#)

match8

8-bit binary match detector.

select8

8-bit binary match detector.

8.2.3 Arithmetic and float-components

abs

Compute the absolute value and sign of the input signal.

blend

Perform linear interpolation between two values.

comp

Two input comparator with hysteresis.

constant

Use a parameter to set the value of a pin.

sum2

Sum of two inputs (each with a gain) and an offset.

counter

Counts input pulses (deprecated). Use the [encoder](#) component.

updown

Counts up or down, with optional limits and wraparound behavior.

ddt

Compute the derivative of the input function.

deadzone

Return the center if within the threshold.

hypot

Three-input hypotenuse (Euclidean distance) calculator.

mult2

Product of two inputs.

mux16

Select from one of sixteen input values.

mux2

Select from one of two input values.

mux4

Select from one of four input values.

mux8

Select from one of eight input values.

near

Determine whether two values are roughly equal.

offset

Adds an offset to an input, and subtracts it from the feedback value.

integ

Integrator.

invert

Compute the inverse of the input signal.

wcomp

Window comparator.

weighted_sum

Convert a group of bits to an integer.

biquad

Biquad IIR filter

lowpass

Low-pass filter

limit1

Limit the output signal to fall between min and max. ¹

limit2

Limit the output signal to fall between min and max. Limit its slew rate to less than maxv per second. ²

limit3

Limit the output signal to fall between min and max. Limit its slew rate to less than maxv per second. Limit its second derivative to less than MaxA per second squared. ³

maj3

Compute the majority of 3 inputs.

scale

Applies a scale and offset to its input.

8.2.4 Type conversion

conv_bit_s32

Convert a value from bit to s32.

conv_bit_u32

Convert a value from bit to u32.

conv_float_s32

Convert a value from float to s32.

¹ When the input is a position, this means that the *position* is limited.

² When the input is a position, this means that *position* and *velocity* are limited.

³ When the input is a position, this means that the *position*, *velocity*, and *acceleration* are limited.

conv_float_u32

Convert a value from float to u32.

conv_s32_bit

Convert a value from s32 to bit.

conv_s32_float

Convert a value from s32 to float.

conv_s32_u32

Convert a value from s32 to u32.

conv_u32_bit

Convert a value from u32 to bit.

conv_u32_float

Convert a value from u32 to float.

conv_u32_s32

Convert a value from u32 to s32.

8.2.5 Hardware drivers

hm2_7i43

HAL driver for the Mesa Electronics 7i43 EPP Anything IO board with HostMot2.

hm2_pci

HAL driver for the Mesa Electronics 5i20, 5i22, 5i23, 4i65, and 4i68 Anything I/O boards, with HostMot2 firmware.

hostmot2

HAL driver for the Mesa Electronics HostMot2 firmware.

mesa_7i65

Support for the Mesa 7i65 eight-axis servo card.

pluto_servo

Hardware driver and firmware for the Pluto-P parallel-port FPGA, for use with servos.

pluto_step

Hardware driver and firmware for the Pluto-P parallel-port FPGA, for use with steppers.

thc

Torch Height Control using a Mesa THC card.

serport

Hardware driver for the digital I/O bits of the 8250 and 16550 serial port.

8.2.6 Kinematics

kins

kinematics definitions for LinuxCNC.

gantrykins

A kinematics module that maps one axis to multiple joints.

genhexkins

Gives six degrees of freedom in position and orientation (XYZABC). The location of the motors is defined at compile time.

genserkins

Kinematics that can model a general serial-link manipulator with up to 6 angular joints.

maxkins

Kinematics for a tabletop 5 axis mill named *max* with tilting head (B axis) and horizontal rotary mounted to the table (C axis). Provides UVW motion in the rotated coordinate system. The source file, `maxkins.c`, may be a useful starting point for other 5-axis systems.

tripodkins

The joints represent the distance of the controlled point from three predefined locations (the motors), giving three degrees of freedom in position (XYZ).

trivkins

There is a 1:1 correspondence between joints and axes. Most standard milling machines and lathes use the trivial kinematics module.

pumakins

Kinematics for PUMA-style robots.

rotatekins

The X and Y axes are rotated 45 degrees compared to the joints 0 and 1.

scarakins

Kinematics for SCARA-type robots.

8.2.7 Motor control

at_pid

Proportional/integral/derivative controller with auto tuning.

pid

Proportional/integral/derivative controller. [Description](#)

pwmgen

Software PWM/PDM generation. [Description](#)

encoder

Software counting of quadrature encoder signals. [Description](#).

stepgen

Software step pulse generation. [Description](#).

freqgen

Software step pulse generation.

8.2.8 BLDC and 3-phase motor control

bldc_hall3

3-wire Bipolar trapezoidal commutation BLDC motor driver using Hall sensors.

clarke2

Two input version of Clarke transform.

clarke3

Clarke (3 phase to cartesian) transform.

clarkein

Inverse Clarke transform.

8.2.9 Other

charge_pump

Creates a square-wave for the *charge pump* input of some controller boards. The *Charge Pump* should be added to the base thread function. When enabled the output is on for one period and off for one period. To calculate the frequency of the output $1/(\text{period time in seconds} \times 2) = \text{hz}$. For example if you have a base period of 100,000ns that is 0.0001 seconds and the formula would be $1/(0.0001 \times 2) = 5,000 \text{ hz}$ or 5 Khz.

encoder_ratio

An electronic gear to synchronize two axes.

estop_latch

ESTOP latch.

feedcomp

Multiply the input by the ratio of current velocity to the feed rate.

gearchange

Select from one of two speed ranges.

ilowpass

While it may find other applications, this component was written to create smoother motion while jogging with an MPG. In a machine with high acceleration, a short jog can behave almost like a step function. By putting the ilowpass component between the MPG encoder counts output and the axis jog-counts input, this can be smoothed.

Choose scale conservatively so that during a single session there will never be more than about $2e9/\text{scale}$ pulses seen on the MPG. Choose gain according to the smoothing level desired. Divide the axis.N.jog-scale values by scale.

joyhandle

Sets nonlinear joypad movements, deadbands and scales.

knob2float

Convert counts (probably from an encoder) to a float value.

minmax

Track the minimum and maximum values of the input to the outputs.

sample_hold

Sample and Hold.

sampler

Sample data from HAL in real time.

siggen

Signal generator. [Description](#).

sim_encoder

Simulated quadrature encoder. [Description](#).

sphereprobe

Probe a pretend hemisphere.

steptest

Used by Stepconf to allow testing of acceleration and velocity values for an axis.

streamer

Stream file data into HAL in real time.

supply

Set output pins with values from parameters (deprecated).

threadtest

Component for testing thread behavior.

time

Accumulated run-time timer counts HH:MM:SS of *active* input.

timedelay

The equivalent of a time-delay relay.

timedelta

Component that measures thread scheduling timing behavior.

toggle2nist

Toggle button to nist logic.

toggle

Push-on, push-off from momentary pushbuttons.

tristate_bit

Place a signal on an I/O pin only when enabled, similar to a tristate buffer in electronics.

tristate_float

Place a signal on an I/O pin only when enabled, similar to a tristate buffer in electronics.

watchdog

Monitor one to thirty-two inputs for a *heartbeat*.

8.3 HAL API calls

```
hal_add_funcnt_to_thread.3hal  
hal_bit_t.3hal  
hal_create_thread.3hal  
hal_del_funcnt_from_thread.3hal  
hal_exit.3hal  
hal_export_funcnt.3hal  
hal_float_t.3hal  
hal_get_lock.3hal  
hal_init.3hal  
hal_link.3hal  
hal_malloc.3hal  
hal_param_bit_new.3hal  
hal_param_bit_newf.3hal  
hal_param_float_new.3hal  
hal_param_float_newf.3hal  
hal_param_new.3hal  
hal_param_s32_new.3hal  
hal_param_s32_newf.3hal  
hal_param_u32_new.3hal  
hal_param_u32_newf.3hal  
hal_parport.3hal  
hal_pin_bit_new.3hal  
hal_pin_bit_newf.3hal  
hal_pin_float_new.3hal  
hal_pin_float_newf.3hal  
hal_pin_new.3hal  
hal_pin_s32_new.3hal  
hal_pin_s32_newf.3hal  
hal_pin_u32_new.3hal  
hal_pin_u32_newf.3hal  
hal_ready.3hal  
hal_s32_t.3hal
```

hal_set_constructor.3hal
hal_set_lock.3hal
hal_signal_delete.3hal
hal_signal_new.3hal
hal_start_threads.3hal
hal_type_t.3hal
hal_u32_t.3hal
hal_unlink.3hal
intro.3hal
undocumented.3hal

8.4 RTAPI calls

EXPORT_FUNCTION.3rtapi
MODULE_AUTHOR.3rtapi
MODULE_DESCRIPTION.3rtapi
MODULE_LICENSE.3rtapi
RTAPI_MP_ARRAY_INT.3rtapi
RTAPI_MP_ARRAY_LONG.3rtapi
RTAPI_MP_ARRAY_STRING.3rtapi
RTAPI_MP_INT.3rtapi
RTAPI_MP_LONG.3rtapi
RTAPI_MP_STRING.3rtapi
intro.3rtapi
rtapi_app_exit.3rtapi
rtapi_app_main.3rtapi
rtapi_clock_set_period.3rtapi
rtapi_delay.3rtapi
rtapi_delay_max.3rtapi
rtapi_exit.3rtapi
rtapi_get_clocks.3rtapi
rtapi_get_msg_level.3rtapi
rtapi_get_time.3rtapi
rtapi_inb.3rtapi
rtapi_init.3rtapi
rtapi_module_param.3rtapi
RTAPI_MP_ARRAY_INT.3rtapi
RTAPI_MP_ARRAY_LONG.3rtapi
RTAPI_MP_ARRAY_STRING.3rtapi
RTAPI_MP_INT.3rtapi
RTAPI_MP_LONG.3rtapi
RTAPI_MP_STRING.3rtapi
rtapi_mutex.3rtapi
rtapi_outb.3rtapi
rtapi_print.3rtapi
rtapi_prio.3rtapi
rtapi_prio_highest.3rtapi
rtapi_prio_lowest.3rtapi
rtapi_prio_next_higher.3rtapi
rtapi_prio_next_lower.3rtapi
rtapi_region.3rtapi
rtapi_release_region.3rtapi
rtapi_request_region.3rtapi
rtapi_set_msg_level.3rtapi
rtapi_shmem.3rtapi

```
rtapi_shmem_delete.3rtapi
rtapi_shmem_getptr.3rtapi
rtapi_shmem_new.3rtapi
rtapi_snprintf.3rtapi
rtapi_task_delete.3rtapi
rtapi_task_new.3rtapi
rtapi_task_pause.3rtapi
rtapi_task_resume.3rtapi
rtapi_task_start.3rtapi
rtapi_task_wait.3rtapi
```

Chapter 9

HAL Component Descriptions

9.1 Steppen

This component provides software based generation of step pulses in response to position or velocity commands. In position mode, it has a built in pre-tuned position loop, so PID tuning is not required. In velocity mode, it drives a motor at the commanded speed, while obeying velocity and acceleration limits. It is a realtime component only, and depending on CPU speed, etc, is capable of maximum step rates of 10kHz to perhaps 50kHz. Figure [Step Pulse Generator Block Diagram](#) shows three block diagrams, each is a single step pulse generator. The first diagram is for step type 0, (step and direction). The second is for step type 1 (up/down, or pseudo-PWM), and the third is for step types 2 through 14 (various stepping patterns). The first two diagrams show position mode control, and the third one shows velocity mode. Control mode and step type are set independently, and any combination can be selected.

Step Pulse Generator Block Diagram position mode

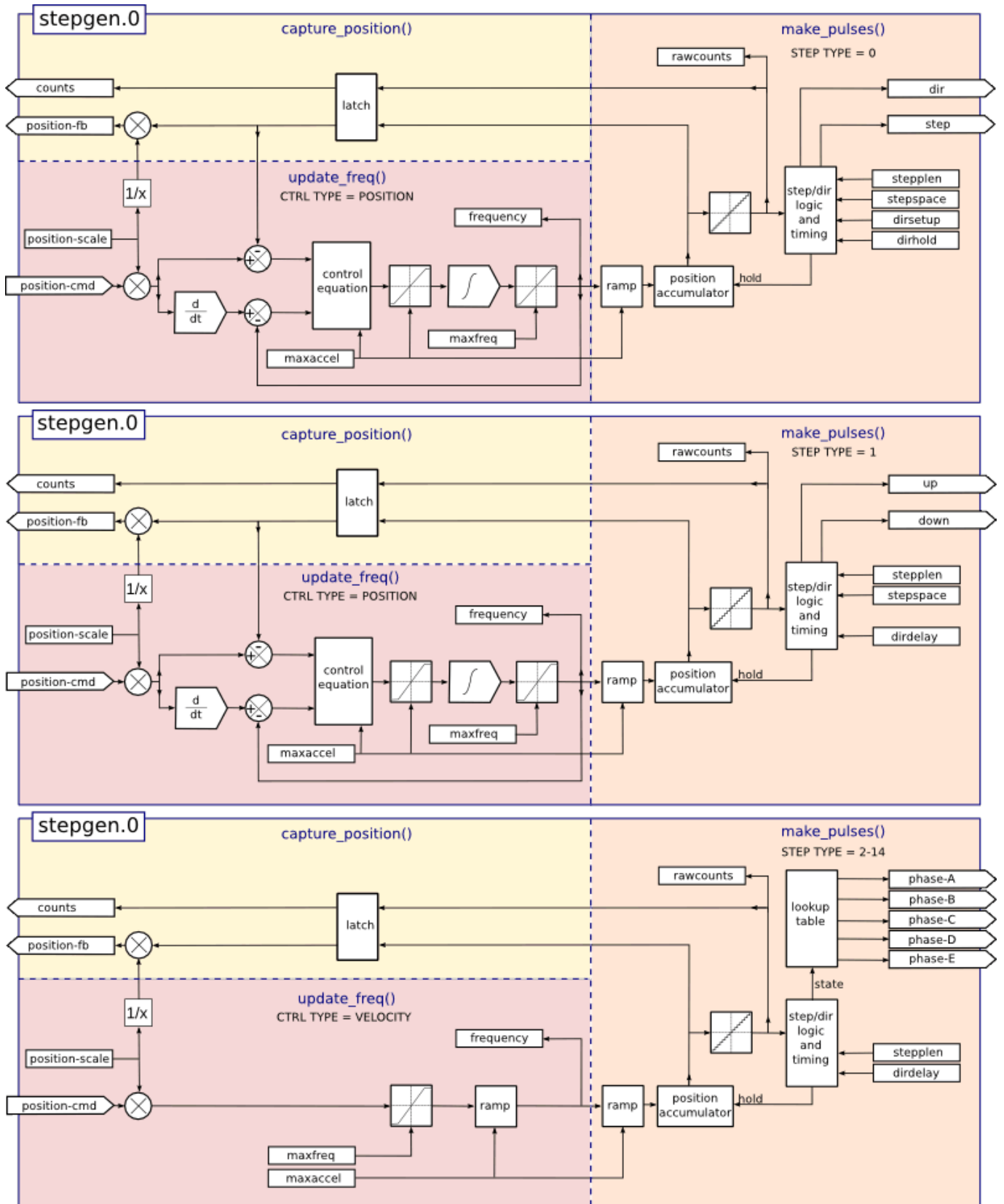

Installing

```
halcmd: loadrt stepgen step_type=<type-array> [ctrl_type=<ctrl_array>]
```

<type-array> is a series of comma separated decimal integers. Each number causes a single step pulse generator to be loaded, the value of the number determines the stepping type. <ctrl_array> is a comma separated series of *p* or *v* characters, to specify position or velocity mode. *ctrl_type* is optional, if omitted, all of the step generators will be position mode.

For example:

```
halcmd: loadrt stepgen step_type=0,0,2 ctrl_type=p,p,v
```

will install three step generators. The first two use step type 0 (step and direction) and run in position mode. The last one uses step type 2 (quadrature) and runs in velocity mode. The default value for <config-array> is 0,0,0 which will install three type 0 (step/dir) generators. The maximum number of step generators is 8 (as defined by MAX_CHAN in stepgen.c). Each generator is independent, but all are updated by the same function(s) at the same time. In the following descriptions, <chan> is the number of a specific generator. The first generator is number 0. .Removing

```
halcmd: unloadrt stepgen
```

Pins Each step pulse generator will have only some of these pins, depending on the step type and control type selected.

- (float) *stepgen.<chan>.position-cmd* - Desired motor position, in position units (position mode only).
- (float) *stepgen.<chan>.velocity-cmd* - Desired motor velocity, in position units per second (velocity mode only).
- (s32) *stepgen.<chan>.counts* - Feedback position in counts, updated by *capture_position()*.
- (float) *stepgen.<chan>.position-fb* - Feedback position in position units, updated by *capture_position()*.
- (bit) *stepgen.<chan>.enable* - Enables output steps - when false, no steps are generated.
- (bit) *stepgen.<chan>.step* - Step pulse output (step type 0 only).
- (bit) *stepgen.<chan>.dir* - Direction output (step type 0 only).
- (bit) *stepgen.<chan>.up* - UP pseudo-PWM output (step type 1 only).
- (bit) *stepgen.<chan>.down* - DOWN pseudo-PWM output (step type 1 only).
- (bit) *stepgen.<chan>.phase-A* - Phase A output (step types 2-14 only).
- (bit) *stepgen.<chan>.phase-B* - Phase B output (step types 2-14 only).
- (bit) *stepgen.<chan>.phase-C* - Phase C output (step types 3-14 only).
- (bit) *stepgen.<chan>.phase-D* - Phase D output (step types 5-14 only).
- (bit) *stepgen.<chan>.phase-E* - Phase E output (step types 11-14 only).

PARAMETERS

- (float) *stepgen.<chan>.position-scale* - Steps per position unit. This parameter is used for both output and feedback.
- (float) *stepgen.<chan>.maxvel* - Maximum velocity, in position units per second. If 0.0, has no effect.
- (float) *stepgen.<chan>.maxaccel* - Maximum accel/decel rate, in positions units per second squared. If 0.0, has no effect.
- (float) *stepgen.<chan>.frequency* - The current step rate, in steps per second.
- (float) *stepgen.<chan>.steplen* - Length of a step pulse (step type 0 and 1) or minimum time in a given state (step types 2-14), in nano-seconds.
- (float) *stepgen.<chan>.stepspace* - Minimum spacing between two step pulses (step types 0 and 1 only), in nano-seconds. Set to 0 to enable the stepgen *doublefreq* function. To use *doublefreq* the [parport reset function](#) must be enabled.
- (float) *stepgen.<chan>.dirsetup* - Minimum time from a direction change to the beginning of the next step pulse (step type 0 only), in nanoseconds.

- (float) *stepgen.<chan>.dirhold* - Minimum time from the end of a step pulse to a direction change (step type 0 only), in nanoseconds.
- (float) *stepgen.<chan>.dirdelay* - Minimum time any step to a step in the opposite direction (step types 1-14 only), in nanoseconds.
- (s32) *stepgen.<chan>.rawcounts* - The raw feedback count, updated by *make_pulses()*.

In position mode, the values of *maxvel* and *maxaccel* are used by the internal position loop to avoid generating step pulse trains that the motor cannot follow. When set to values that are appropriate for the motor, even a large instantaneous change in commanded position will result in a smooth trapezoidal move to the new location. The algorithm works by measuring both position error and velocity error, and calculating an acceleration that attempts to reduce both to zero at the same time. For more details, including the contents of the *control equation* box, consult the code.

In velocity mode, *maxvel* is a simple limit that is applied to the commanded velocity, and *maxaccel* is used to ramp the actual frequency if the commanded velocity changes abruptly. As in position mode, proper values for these parameters ensure that the motor can follow the generated pulse train.

Step Type 0

Step type 0 is the standard step and direction type. When configured for step type 0, there are four extra parameters that determine the exact timing of the step and direction signals. In the following figure the meaning of these parameters is shown. The parameters are in nanoseconds, but will be rounded up to an integer multiple of the thread period for the thread that calls *make_pulses()*. For example, if *make_pulses()* is called every 16 us, and *steplen* is 20000, then the step pulses will be $2 \times 16 = 32$ us long. The default value for all four of the parameters is 1 ns, but the automatic rounding takes effect the first time the code runs. Since one step requires *steplen* ns high and *stepspace* ns low, the maximum frequency is 1,000,000,000 divided by (*steplen*+*stepspace*). If *maxfreq* is set higher than that limit, it will be lowered automatically. If *maxfreq* is zero, it will remain zero, but the output frequency will still be limited.

When using the parallel port driver the step frequency can be doubled using the [parport reset](#) function together with *stepgen's* *doublefreq* setting.

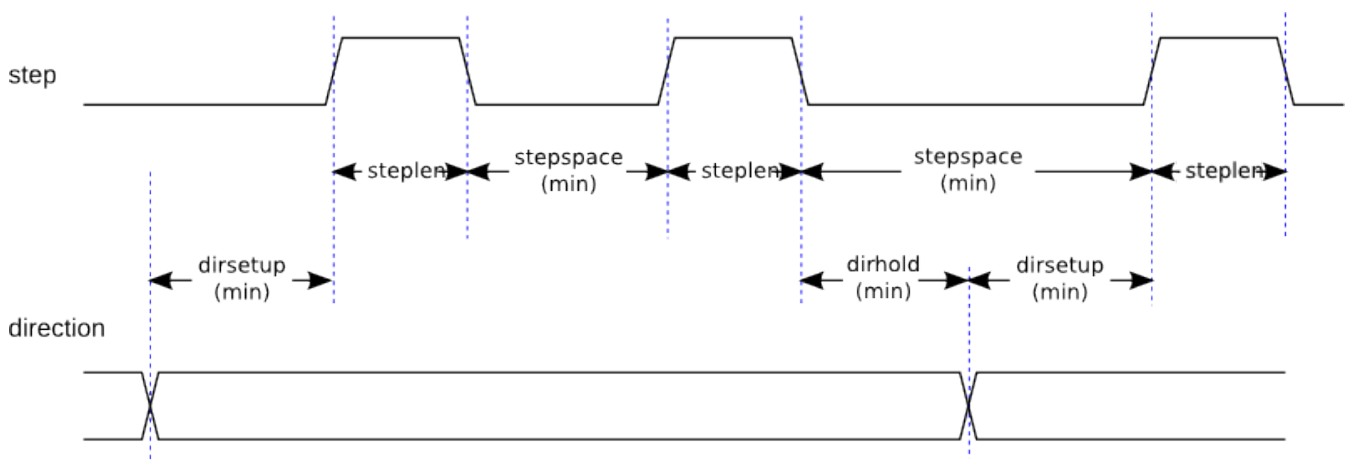

Figure 9.1: Step and Direction Timing

Step Type 1 Step type 1 has two outputs, up and down. Pulses appear on one or the other, depending on the direction of travel. Each pulse is *steplen* ns long, and the pulses are separated by at least *stepspace* ns. The maximum frequency is the same as for step type 0. If *maxfreq* is set higher than the limit it will be lowered. If *maxfreq* is zero, it will remain zero but the output frequency will still be limited.



Warning

Do not use the [parport reset](#) function with step types 2 - 14. Unexpected results can happen.

Step Type 2 - 14 Step types 2 through 14 are state based, and have from two to five outputs. On each step, a state counter is incremented or decremented. Figures [Two-and-Three-Phase](#), [Four-Phase](#), and [Five-Phase](#) show the output patterns as a function of the state counter. The maximum frequency is 1,000,000,000 divided by *steplen*, and as in the other modes, *maxfreq* will be lowered if it is above the limit.

Two-and-Three-Phase Step Types

STEP TYPE 2

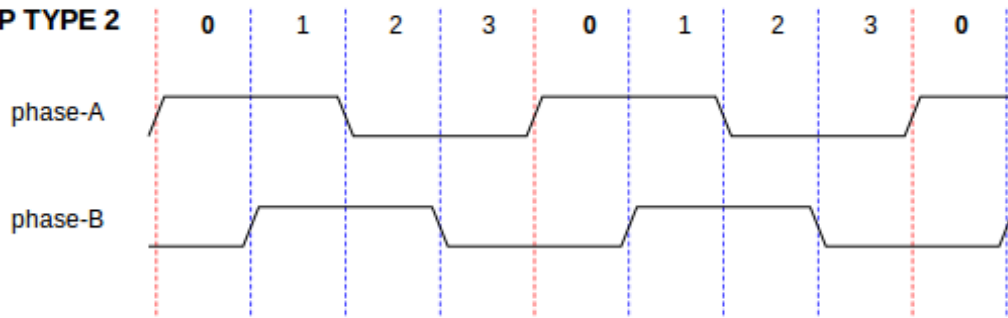

STEP TYPE 3

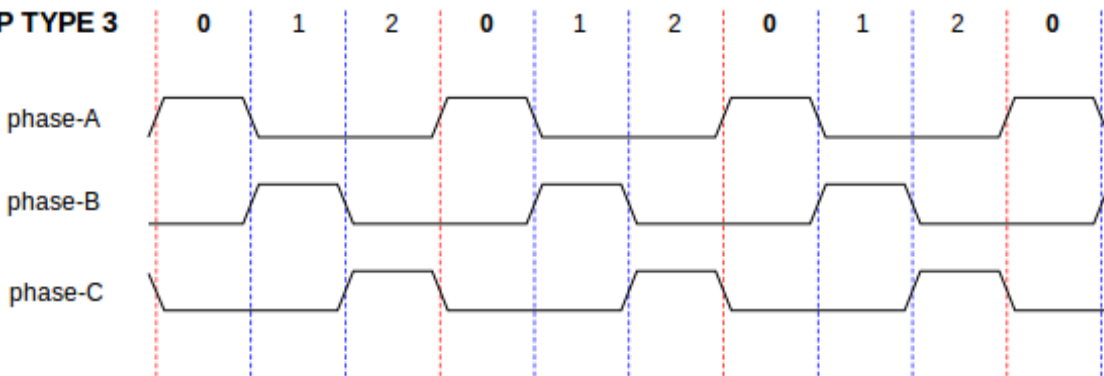

STEP TYPE 4

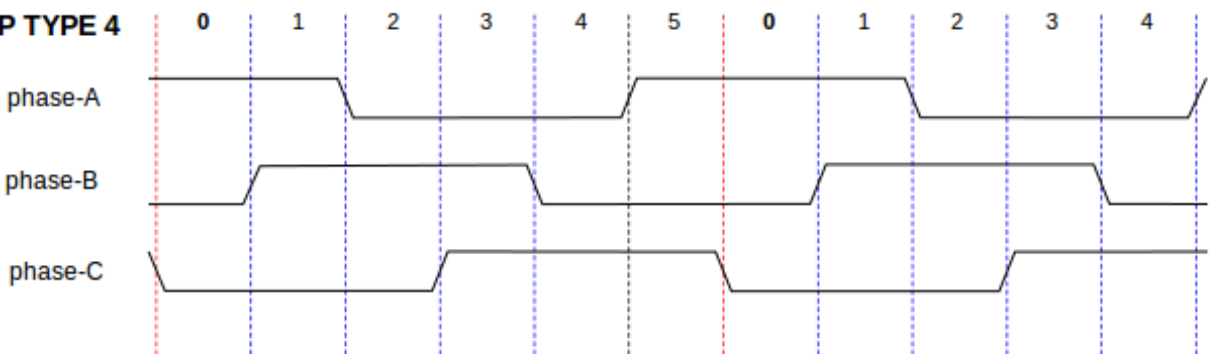

Four-Phase Step Types

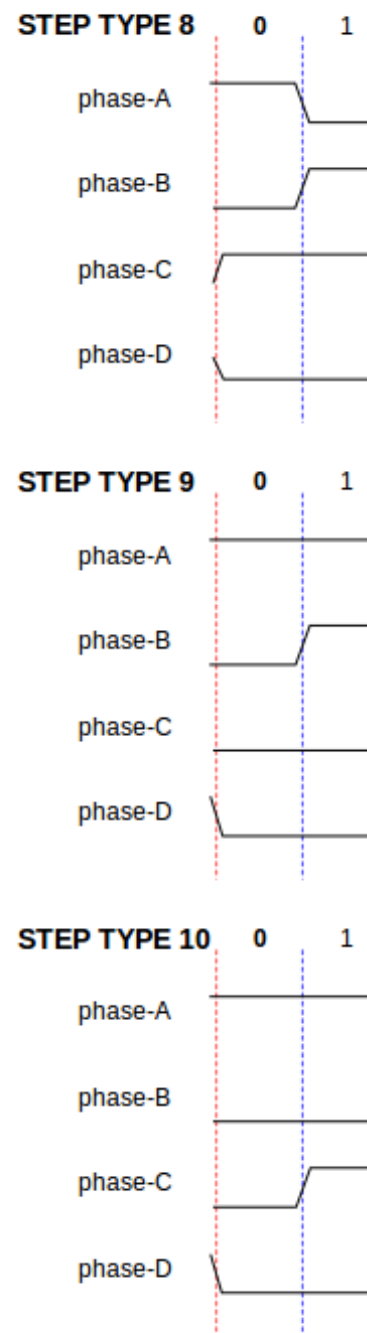
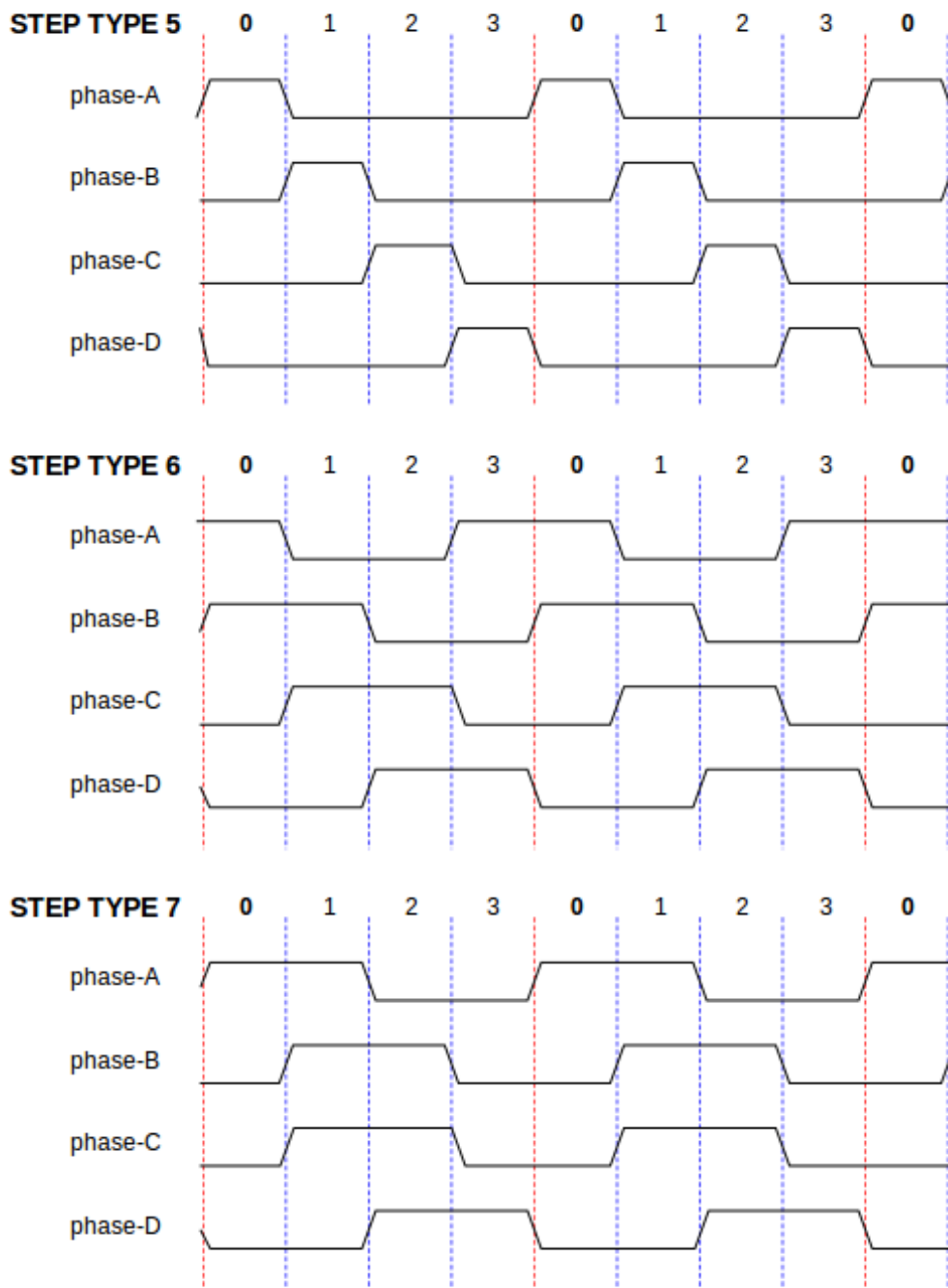

Five-Phase Step Types

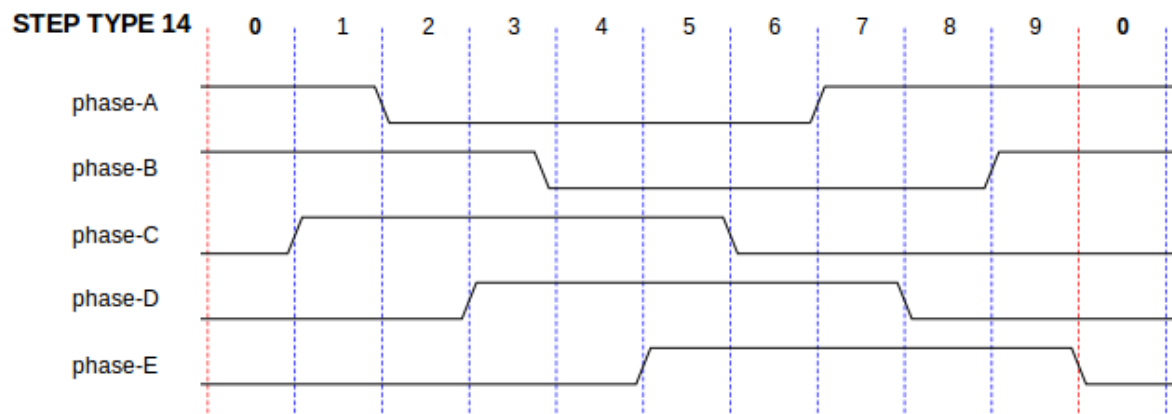
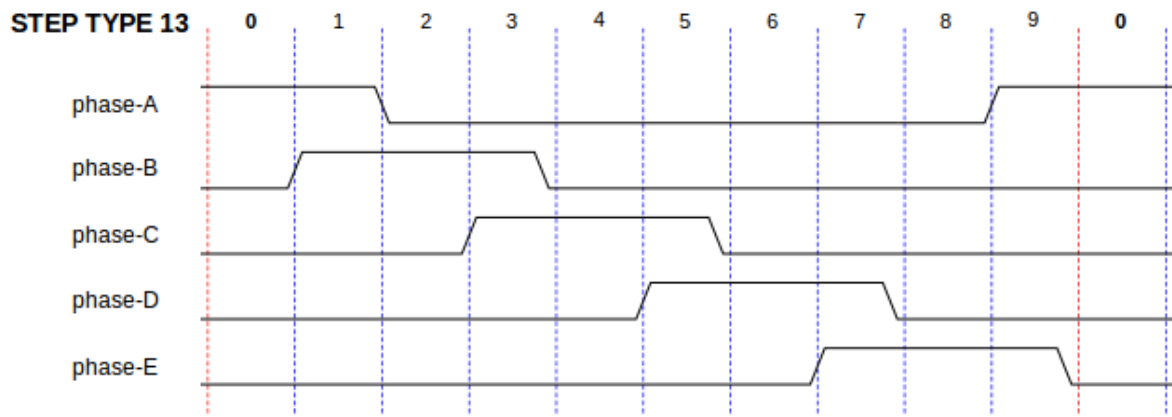
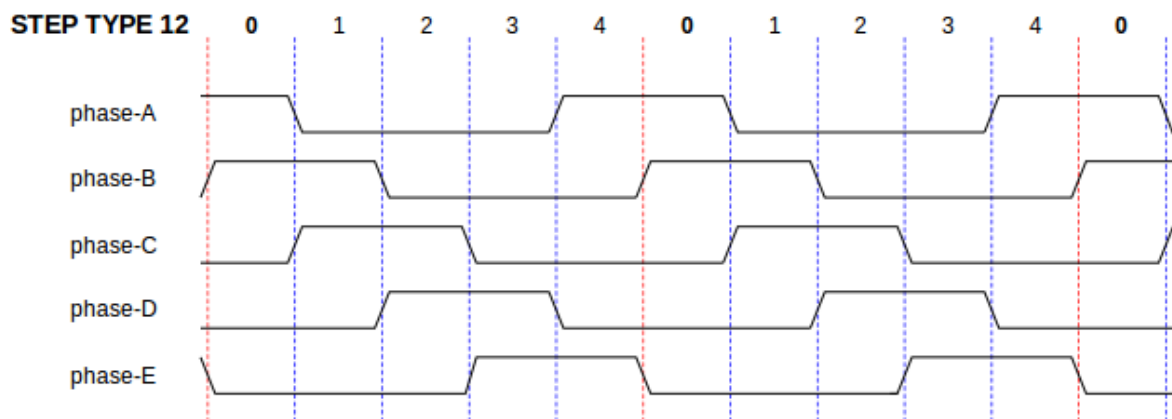
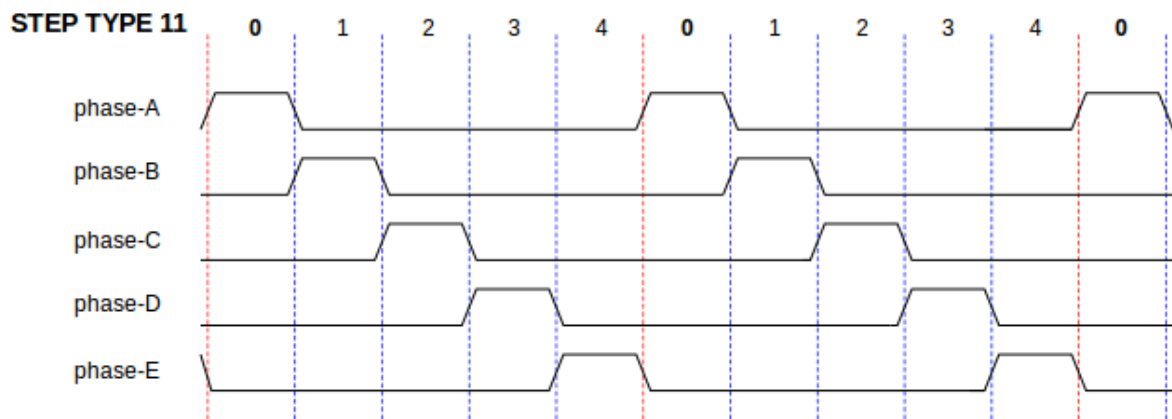

Functions The component exports three functions. Each function acts on all of the step pulse generators - running different generators in different threads is not supported.

- (funct) *stepgen.make-pulses* - High speed function to generate and count pulses (no floating point).
- (funct) *stepgen.update-freq* - Low speed function does position to velocity conversion, scaling and limiting.
- (funct) *stepgen.capture-position* - Low speed function for feedback, updates latches and scales position.

The high speed function *stepgen.make-pulses* should be run in a very fast thread, from 10 to 50 us depending on the capabilities of the computer. That thread's period determines the maximum step frequency, since *steplen*, *stepspace*, *dirsetup*, *dirhold*, and *dirdelay* are all rounded up to a integer multiple of the thread period in nanoseconds. The other two functions can be called at a much lower rate.

9.2 PWMgen

This component provides software based generation of PWM (Pulse Width Modulation) and PDM (Pulse Density Modulation) waveforms. It is a realtime component only, and depending on CPU speed, etc, is capable of PWM frequencies from a few hundred Hertz at pretty good resolution, to perhaps 10KHz with limited resolution.

Installing

```
loadrt pwmgen output_type=<config-array>
```

The *<config-array>* is a series of comma separated decimal integers. Each number causes a single PWM generator to be loaded, the value of the number determines the output type. The following example will install three PWM generators. There is no default value, if *<config-array>* is not specified, no PWM generators will be installed. The maximum number of frequency generators is 8 (as defined by *MAX_CHAN* in *pwmgen.c*). Each generator is independent, but all are updated by the same function(s) at the same time. In the following descriptions, *<chan>* is the number of a specific generator. The first generator is number 0.

Example

```
loadrt pwmgen output_type=0,1,2
```

Removing

```
unloadrt pwmgen
```

Output Types The PWM generator supports three different *output types*.

- *Output type 0* - PWM output pin only. Only positive commands are accepted, negative values are treated as zero (and will be affected by the parameter *min-dc* if it is non-zero).
- *Output type 1* - PWM/PDM and direction pins. Positive and negative inputs will be output as positive and negative PWM. The direction pin is false for positive commands, and true for negative commands. If your control needs positive PWM for both CW and CCW use the [abs](#) component to convert your PWM signal to positive value when a negative input is input.
- *Output type 2* - UP and DOWN pins. For positive commands, the PWM signal appears on the up output, and the down output remains false. For negative commands, the PWM signal appears on the down output, and the up output remains false. Output type 2 is suitable for driving most H-bridges.

Pins Each PWM generator will have the following pins:

- (float) *pwmgen.<chan>.value* - Command value, in arbitrary units. Will be scaled by the *scale* parameter (see below).
- (bit) *pwmgen.<chan>.enable* - Enables or disables the PWM generator outputs.

Each PWM generator will also have some of these pins, depending on the output type selected:

- (bit) *pwmgen.<chan>.pwm* - PWM (or PDM) output, (output types 0 and 1 only).
- (bit) *pwmgen.<chan>.dir* - Direction output (output type 1 only).
- (bit) *pwmgen.<chan>.up* - PWM/PDM output for positive input value (output type 2 only).
- (bit) *pwmgen.<chan>.down* - PWM/PDM output for negative input value (output type 2 only).

PARAMETERS

- (float) *pwmgen.<chan>.scale* - Scaling factor to convert *value* from arbitrary units to duty cycle.
- (float) *pwmgen.<chan>.pwm-freq* - Desired PWM frequency, in Hz. If 0.0, generates PDM instead of PWM. If set higher than internal limits, next call of *update_freq()* will set it to the internal limit. If non-zero, and *dither* is false, next call of *update_freq()* will set it to the nearest integer multiple of the *make_pulses()* function period.
- (bit) *pwmgen.<chan>.dither-pwm* - If true, enables dithering to achieve average PWM frequencies or duty cycles that are unobtainable with pure PWM. If false, both the PWM frequency and the duty cycle will be rounded to values that can be achieved exactly.
- (float) *pwmgen.<chan>.min-dc* - Minimum duty cycle, between 0.0 and 1.0 (duty cycle will go to zero when disabled, regardless of this setting).
- (float) *pwmgen.<chan>.max-dc* - Maximum duty cycle, between 0.0 and 1.0.
- (float) *pwmgen.<chan>.curr-dc* - Current duty cycle - after all limiting and rounding (read only).

Functions The component exports two functions. Each function acts on all of the PWM generators - running different generators in different threads is not supported.

- (funct) *pwmgen.make-pulses* - High speed function to generate PWM waveforms (no floating point).
- (funct) *pwmgen.update* - Low speed function to scale and limit value and handle other parameters.

The high speed function *pwmgen.make-pulses* should be run in a very fast thread, from 10 to 50 us depending on the capabilities of the computer. That thread's period determines the maximum PWM carrier frequency, as well as the resolution of the PWM or PDM signals. The other function can be called at a much lower rate.

9.3 Encoder

This component provides software based counting of signals from quadrature encoders. It is a realtime component only, and depending on CPU speed, latency, etc, is capable of maximum count rates of 10kHz to perhaps up to 50kHz.

The base thread should be 1/2 count speed to allow for noise and timing variation. For example if you have a 100 pulse per revolution encoder on the spindle and your maximum RPM is 3000 the maximum base thread should be 25 us. A 100 pulse per revolution encoder will have 400 counts. The spindle speed of 3000 RPM = 50 RPS (revolutions per second). $400 * 50 = 20,000$ counts per second or 50 us between counts.

Figure [Encoder Counter Block Diagram](#) is a block diagram of one channel of encoder counter.

Encoder Counter Block Diagram

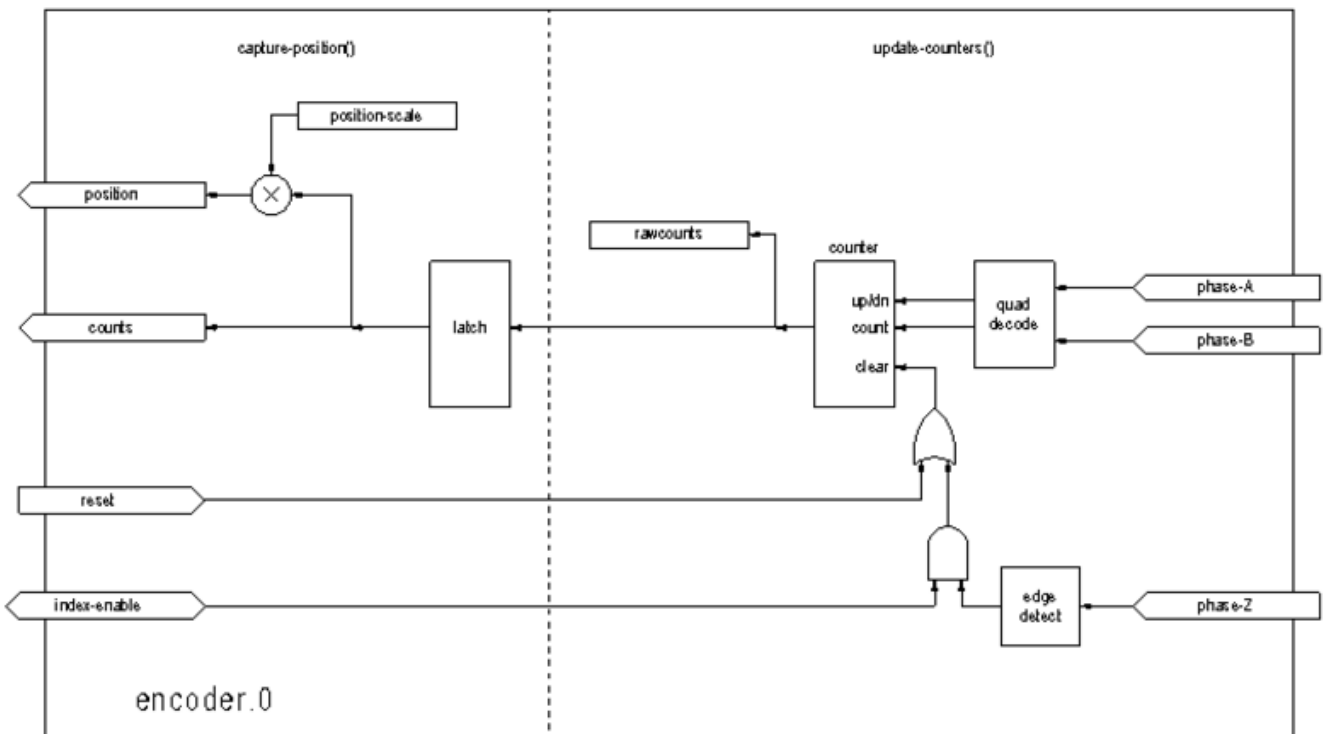

Installing

```
halcmd: loadrt encoder [num_chan=<counters>]
```

`<counters>` is the number of encoder counters that you want to install. If `numchan` is not specified, three counters will be installed. The maximum number of counters is 8 (as defined by `MAX_CHAN` in `encoder.c`). Each counter is independent, but all are updated by the same function(s) at the same time. In the following descriptions, `<chan>` is the number of a specific counter. The first counter is number 0.

Removing

```
halcmd: unloadrt encoder
```

PINS

- `encoder.<chan>.counter-mode` (bit, I/O) (default: FALSE) - Enables counter mode. When true, the counter counts each rising edge of the phase-A input, ignoring the value on phase-B. This is useful for counting the output of a single channel (non-quadrature) sensor. When false, it counts in quadrature mode.
- `encoder.<chan>.counts` (s32, Out) - Position in encoder counts.
- `encoder.<chan>.counts-latched` (s32, Out) - Not used at this time.
- `encoder.<chan>.index-enable` (bit, I/O) - When True, `counts` and `position` are reset to zero on next rising edge of Phase Z. At the same time, `index-enable` is reset to zero to indicate that the rising edge has occurred. The `index-enable` pin is bi-directional. If `index-enable` is False, the Phase Z channel of the encoder will be ignored, and the counter will count normally. The encoder driver will never set `index-enable` True. However, some other component may do so.

- *encoder.<chan>.latch-falling* (bit, In) (default: TRUE) - Not used at this time.
- *encoder.<chan>.latch-input* (bit, In) (default: TRUE) - Not used at this time.
- *encoder.<chan>.latch-rising* (bit, In) - Not used at this time.
- *encoder.<chan>.min-speed-estimate* (float, in) - Determine the minimum true velocity magnitude at which velocity will be estimated as nonzero and position-interpolated will be interpolated. The units of *min-speed-estimate* are the same as the units of *velocity*. Scale factor, in counts per length unit. Setting this parameter too low will cause it to take a long time for velocity to go to 0 after encoder pulses have stopped arriving.
- *encoder.<chan>.phase-A* (bit, In) - Phase A of the quadrature encoder signal.
- *encoder.<chan>.phase-B* (bit, In) - Phase B of the quadrature encoder signal.
- *encoder.<chan>.phase-Z* (bit, In) - Phase Z (index pulse) of the quadrature encoder signal.
- *encoder.<chan>.position* (float, Out) - Position in scaled units (see *position-scale*).
- *encoder.<chan>.position-interpolated* (float, Out) - Position in scaled units, interpolated between encoder counts. The *position-interpolated* attempts to interpolate between encoder counts, based on the most recently measured velocity. Only valid when velocity is approximately constant and above *min-speed-estimate*. Do not use for position control, since its value is incorrect at low speeds, during direction reversals, and during speed changes. However, it allows a low ppr encoder (including a one pulse per revolution *encoder*) to be used for lathe threading, and may have other uses as well.
- *encoder.<chan>.position-latched* (float, Out) - Not used at this time.
- *encoder.<chan>.position-scale* (float, I/O) - Scale factor, in counts per length unit. For example, if position-scale is 500, then 1000 counts of the encoder will be reported as a position of 2.0 units.
- *encoder.<chan>.rawcounts* (s32, In) - The raw count, as determined by update-counters. This value is updated more frequently than counts and position. It is also unaffected by reset or the index pulse.
- *encoder.<chan>.reset* (bit, In) - When True, force *counts* and *position* to zero immediately.
- *encoder.<chan>.velocity* (float, Out) - Velocity in scaled units per second. *encoder* uses an algorithm that greatly reduces quantization noise as compared to simply differentiating the *position* output. When the magnitude of the true velocity is below min-velocity-estimate, the velocity output is 0.
- *encoder.<chan>.x4-mode* (bit, I/O) (default: TRUE) - Enables times-4 mode. When true, the counter counts each edge of the quadrature waveform (four counts per full cycle). When false, it only counts once per full cycle. In counter-mode, this parameter is ignored. The 1x mode is useful for some jogwheels.

PARAMETERS

- *encoder.<chan>.capture-position.time* (s32, RO)
- *encoder.<chan>.capture-position.tmax* (s32, RW)
- *encoder.<chan>.update-counters.time* (s32, RO)
- *encoder.<chan>.update-counter.tmax* (s32, RW)

Functions The component exports two functions. Each function acts on all of the encoder counters - running different counters in different threads is not supported.

- (funct) *encoder.update-counters* - High speed function to count pulses (no floating point).
- (funct) *encoder.capture-position* - Low speed function to update latches and scale position.

9.4 PID

This component provides Proportional/Integral/Derivative control loops. It is a realtime component only. For simplicity, this discussion assumes that we are talking about position loops, however this component can be used to implement other feedback loops such as speed, torch height, temperature, etc. Figure [PID Loop Block Diagram](#) is a block diagram of a single PID loop.

PID Loop Block Diagram

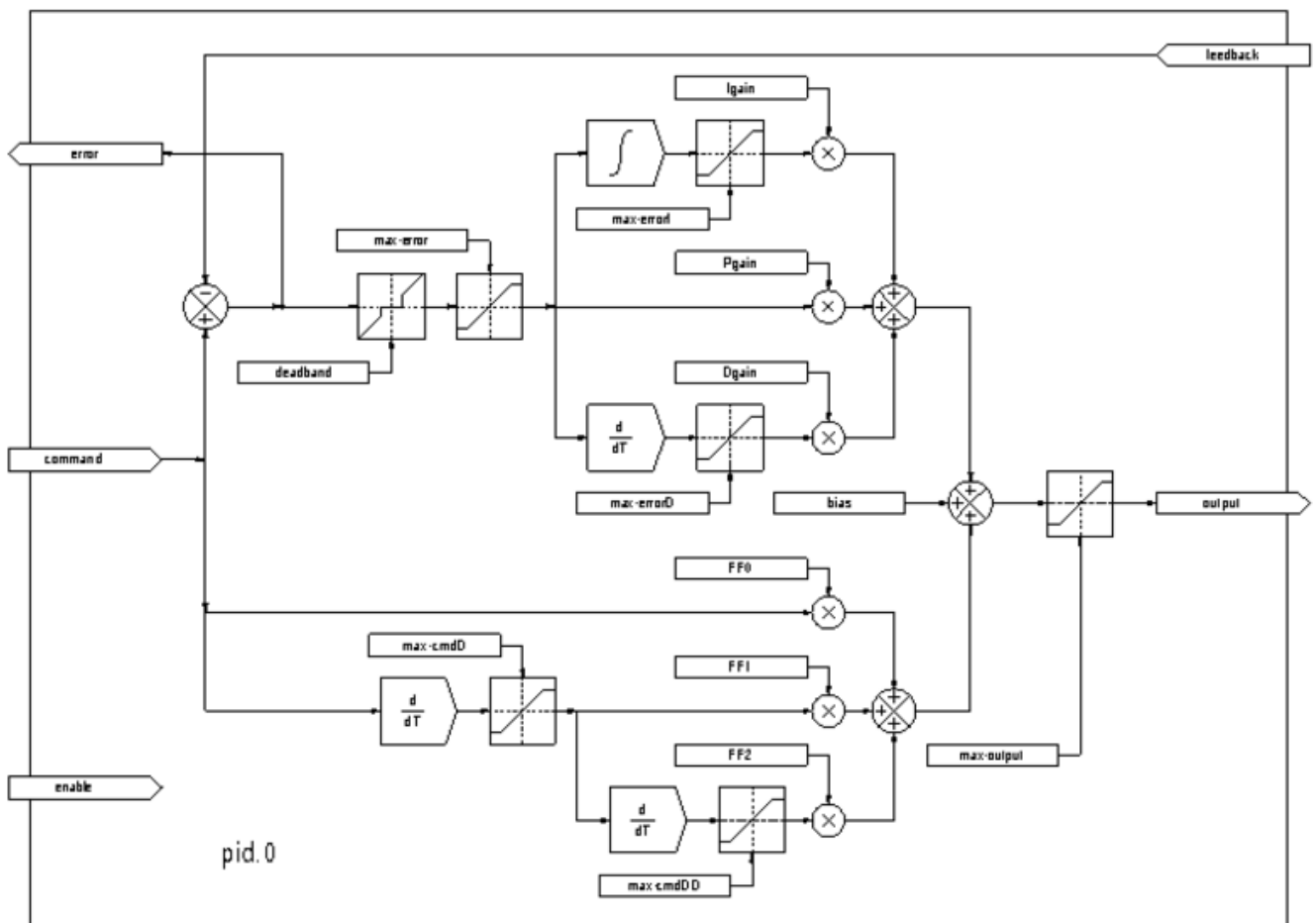

Installing

```
halcmd: loadrt pid [num_chan=<loops>] [debug=1]
```

<loops> is the number of PID loops that you want to install. If *numchan* is not specified, one loop will be installed. The maximum number of loops is 16 (as defined by `MAX_CHAN` in `pid.c`). Each loop is completely independent. In the following descriptions, *<loopnum>* is the loop number of a specific loop. The first loop is number 0.

If *debug=1* is specified, the component will export a few extra parameters that may be useful during debugging and tuning. By default, the extra parameters are not exported, to save shared memory space and avoid cluttering the parameter list.

Removing

```
halcmd: unloadrt pid
```

Pins The three most important pins are

- (float) *pid.<loopnum>.command* - The desired position, as commanded by another system component.
- (float) *pid.<loopnum>.feedback* - The present position, as measured by a feedback device such as an encoder.
- (float) *pid.<loopnum>.output* - A velocity command that attempts to move from the present position to the desired position.

For a position loop, *command* and *feedback* are in position units. For a linear axis, this could be inches, mm, meters, or whatever is relevant. Likewise, for an angular axis, it could be degrees, radians, etc. The units of the *output* pin represent the change needed to make the feedback match the command. As such, for a position loop *Output* is a velocity, in inches/sec, mm/sec, degrees/sec, etc. Time units are always seconds, and the velocity units match the position units. If command and feedback are in meters, then output is in meters per second.

Each loop has two pins which are used to monitor or control the general operation of the component.

- (float) *pid.<loopnum>.error* - Equals *.command* minus *.feedback*.
- (bit) *pid.<loopnum>.enable* - A bit that enables the loop. If *.enable* is false, all integrators are reset, and the output is forced to zero. If *.enable* is true, the loop operates normally.

Pins used to report saturation. Saturation occurs when the output of the PID block is at its maximum or minimum limit.

- (bit) *pid.<loopnum>.saturated* - True when output is saturated.
- (float) *pid.<loopnum>.saturated_s* - The time the output has been saturated.
- (s32) *pid.<loopnum>.saturated_count* - The time the output has been saturated.

Parameters The PID gains, limits, and other *tunable* features of the loop are implemented as parameters.

- (float) *pid.<loopnum>.Pgain* - Proportional gain
- (float) *pid.<loopnum>.Igain* - Integral gain
- (float) *pid.<loopnum>.Dgain* - Derivative gain
- (float) *pid.<loopnum>.bias* - Constant offset on output
- (float) *pid.<loopnum>.FF0* - Zeroth order feedforward - output proportional to command (position).
- (float) *pid.<loopnum>.FF1* - First order feedforward - output proportional to derivative of command (velocity).
- (float) *pid.<loopnum>.FF2* - Second order feedforward - output proportional to 2nd derivative of command (acceleration)¹.
- (float) *pid.<loopnum>.deadband* - Amount of error that will be ignored
- (float) *pid.<loopnum>.maxerror* - Limit on error
- (float) *pid.<loopnum>.maxerrorI* - Limit on error integrator
- (float) *pid.<loopnum>.maxerrorD* - Limit on error derivative
- (float) *pid.<loopnum>.maxcmdD* - Limit on command derivative
- (float) *pid.<loopnum>.maxcmdDD* - Limit on command 2nd derivative
- (float) *pid.<loopnum>.maxoutput* - Limit on output value

All of the *max* limits are implemented such that if the parameter value is zero, there is no limit.

If *debug=1* was specified when the component was installed, four additional parameters will be exported:

- (float) *pid.<loopnum>.errorI* - Integral of error.

¹ FF2 is not currently implemented, but it will be added. Consider this note a “FIXME” for the code

- (float) *pid.<loopnum>.errorD* - Derivative of error.
- (float) *pid.<loopnum>.commandD* - Derivative of the command.
- (float) *pid.<loopnum>.commandDD* - 2nd derivative of the command.

Functions The component exports one function for each PID loop. This function performs all the calculations needed for the loop. Since each loop has its own function, individual loops can be included in different threads and execute at different rates.

- (funct) *pid.<loopnum>.do_pid_calcs* - Performs all calculations for a single PID loop.

If you want to understand the exact algorithm used to compute the output of the PID loop, refer to figure [PID Loop Block Diagram](#), the comments at the beginning of *emc2/src/hal/components/pid.c*, and of course to the code itself. The loop calculations are in the C function *calc_pid()*.

9.5 Simulated Encoder

The simulated encoder is exactly that. It produces quadrature pulses with an index pulse, at a speed controlled by a HAL pin. Mostly useful for testing.

Installing

```
halcmd: loadrt sim-encoder num_chan=<number>
```

<number> is the number of encoders that you want to simulate. If not specified, one encoder will be installed. The maximum number is 8 (as defined by MAX_CHAN in *sim_encoder.c*).

Removing

```
halcmd: unloadrt sim-encoder
```

PINS

- (float) *sim-encoder.<chan-num>.speed* - The speed command for the simulated shaft.
- (bit) *sim-encoder.<chan-num>.phase-A* - Quadrature output.
- (bit) *sim-encoder.<chan-num>.phase-B* - Quadrature output.
- (bit) *sim-encoder.<chan-num>.phase-Z* - Index pulse output.

When *.speed* is positive, *.phase-A* leads *.phase-B*.

PARAMETERS

- (u32) *sim-encoder.<chan-num>.ppr* - Pulses Per Revolution.
- (float) *sim-encoder.<chan-num>.scale* - Scale Factor for *speed*. The default is 1.0, which means that *speed* is in revolutions per second. Change to 60 for RPM, to 360 for degrees per second, 6.283185 for radians per second, etc.

Note that pulses per revolution is not the same as counts per revolution. A pulse is a complete quadrature cycle. Most encoder counters will count four times during one complete cycle.

Functions The component exports two functions. Each function affects all simulated encoders.

- (funct) *sim-encoder.make-pulses* - High speed function to generate quadrature pulses (no floating point).
- (funct) *sim-encoder.update-speed* - Low speed function to read *speed*, do scaling, and set up *make-pulses*.

9.6 Debounce

Debounce is a realtime component that can filter the glitches created by mechanical switch contacts. It may also be useful in other applications where short pulses are to be rejected.

Installing

```
halcmd: loadrt debounce cfg=<config-string>
```

<config-string> is a series of comma separated decimal integers. Each number installs a group of identical debounce filters, the number determines how many filters are in the group.

For example:

```
halcmd: loadrt debounce cfg=1,4,2
```

will install three groups of filters. Group 0 contains one filter, group 1 contains four, and group 2 contains two filters. The default value for *<config-string>* is "1" which will install a single group containing a single filter. The maximum number of groups 8 (as defined by MAX_GROUPS in debounce.c). The maximum number of filters in a group is limited only by shared memory space. Each group is completely independent. All filters in a single group are identical, and they are all updated by the same function at the same time. In the following descriptions, *<G>* is the group number and *<F>* is the filter number within the group. The first filter is group 0, filter 0.

Removing

```
halcmd: unloadrt debounce
```

Pins Each individual filter has two pins.

- *(bit) debounce.<G>.<F>.in* - Input of filter *<F>* in group *<G>*.
- *(bit) debounce.<G>.<F>.out* - Output of filter *<F>* in group *<G>*.

Parameters Each group of filters has one parameter².

- *(s32) debounce.<G>.delay* - Filter delay for all filters in group *<G>*.

The filter delay is in units of thread periods. The minimum delay is zero. The output of a zero delay filter exactly follows its input - it doesn't filter anything. As *delay* increases, longer and longer glitches are rejected. If *delay* is 4, all glitches less than or equal to four thread periods will be rejected.

Functions Each group of filters has one function, which updates all the filters in that group *simultaneously*. Different groups of filters can be updated from different threads at different periods.

- *(funct) debounce.<G>* - Updates all filters in group *<G>*.

9.7 Siggen

Siggen is a realtime component that generates square, triangle, and sine waves. It is primarily used for testing.

Installing

```
halcmd: loadrt siggen [num_chan=<chans>]
```

² Each individual filter also has an internal state variable. There is a compile time switch that can export that variable as a parameter. This is intended for testing, and simply wastes shared memory under normal circumstances.

<chan> is the number of signal generators that you want to install. If *numchan* is not specified, one signal generator will be installed. The maximum number of generators is 16 (as defined by `MAX_CHAN` in `siggen.c`). Each generator is completely independent. In the following descriptions, *<chan>* is the number of a specific signal generator (the numbers start at 0).

Removing

```
halcmd: unloadrt siggen
```

Pins Each generator has five output pins.

- (float) *siggen.<chan>.sine* - Sine wave output.
- (float) *siggen.<chan>.cosine* - Cosine output.
- (float) *siggen.<chan>.sawtooth* - Sawtooth output.
- (float) *siggen.<chan>.triangle* - Triangle wave output.
- (float) *siggen.<chan>.square* - Square wave output.

All five outputs have the same frequency, amplitude, and offset.

In addition to the output pins, there are three control pins:

- (float) *siggen.<chan>.frequency* - Sets the frequency in Hertz, default value is 1 Hz.
- (float) *siggen.<chan>.amplitude* - Sets the peak amplitude of the output waveforms, default is 1.
- (float) *siggen.<chan>.offset* - Sets DC offset of the output waveforms, default is 0.

For example, if *siggen.0.amplitude* is 1.0 and *siggen.0.offset* is 0.0, the outputs will swing from -1.0 to +1.0. If *siggen.0.amplitude* is 2.5 and *siggen.0.offset* is 10.0, then the outputs will swing from 7.5 to 12.5.

Parameters None. ³

FUNCTIONS

- (funct) *siggen.<chan>.update* - Calculates new values for all five outputs.

9.8 lut5

The *lut5* component is a 5 input logic component based on a look up table.

- *lut5* does not require a floating point thread.

Installing

```
loadrt lut5 [count=N|names=name1[,name2...]]
addf lut5.N servo-thread | base-thread
setp lut5.N.function 0xN
```

Computing Function To compute the hexadecimal number for the function starting from the top put a 1 or 0 to indicate if that row would be true or false. Next write down every number in the output column starting from the top and writing them from right to left. This will be the binary number. Using a calculator with a program view like the one in Ubuntu enter the binary number and then convert it to hexadecimal and that will be the value for function.

³ Prior to version 2.1, frequency, amplitude, and offset were parameters. They were changed to pins to allow control by other components.

Table 9.1: Look Up Table

Bit 4	Bit 3	Bit 2	Bit 1	Bit 0	Output
0	0	0	0	0	
0	0	0	0	1	
0	0	0	1	0	
0	0	0	1	1	
0	0	1	0	0	
0	0	1	0	1	
0	0	1	1	0	
0	0	1	1	1	
0	1	0	0	0	
0	1	0	0	1	
0	1	0	1	0	
0	1	0	1	1	
0	1	1	0	0	
0	1	1	0	1	
0	1	1	1	0	
0	1	1	1	1	
1	0	0	0	0	
1	0	0	0	1	
1	0	0	1	0	
1	0	0	1	1	
1	0	1	0	0	
1	0	1	0	1	
1	0	1	1	0	
1	0	1	1	1	
1	1	0	0	0	
1	1	0	0	1	
1	1	0	1	0	
1	1	0	1	1	
1	1	1	0	0	
1	1	1	0	1	
1	1	1	1	0	
1	1	1	1	1	

Two Input Example In the following table we have selected the output state for each line that we wish to be true.

Table 9.2: Look Up Table

Bit 4	Bit 3	Bit 2	Bit 1	Bit 0	Output
0	0	0	0	0	0
0	0	0	0	1	1
0	0	0	1	0	0
0	0	0	1	1	1

Looking at the output column of our example we want the output to be on when Bit 0 or Bit 0 and Bit1 is on and nothing else. The binary number is *b1010* (rotate the output 90 degrees CW). Enter this number into the calculator then change the display to hexadecimal and the number needed for function is *0xa*. The hexadecimal prefix is *0x*.

Chapter 10

Parallel Port Driver

10.1 Parport

Parport is a driver for the traditional PC parallel port. The port has a total of 17 physical pins. The original parallel port divided those pins into three groups: data, control, and status. The data group consists of 8 output pins, the control group consists of 4 pins, and the status group consists of 5 input pins.

In the early 1990's, the bidirectional parallel port was introduced, which allows the data group to be used for output or input. The HAL driver supports the bidirectional port, and allows the user to set the data group as either input or output. If configured as output, a port provides a total of 12 outputs and 5 inputs. If configured as input, it provides 4 outputs and 13 inputs.

In some parallel ports, the control group pins are open collectors, which may also be driven low by an external gate. On a board with open collector control pins, the *x* mode allows a more flexible mode with 8 outputs, and 9 inputs. In other parallel ports, the control group has push-pull drivers and cannot be used as an input.

HAL and Open Collectors

HAL cannot automatically determine if the *x* mode bidirectional pins are actually open collectors (OC). If they are not, they cannot be used as inputs, and attempting to drive them LOW from an external source can damage the hardware.

To determine whether your port has *open collector* pins, load `hal_parport` in *x* mode. With no device attached, HAL should read the pin as TRUE. Next, insert a 470 ohm resistor from one of the control pins to GND. If the resulting voltage on the control pin is close to 0V, and HAL now reads the pin as FALSE, then you have an OC port. If the resulting voltage is far from 0V, or HAL does not read the pin as FALSE, then your port cannot be used in *x* mode.

The external hardware that drives the control pins should also use open collector gates (e.g., 74LS05).

On some machines, BIOS settings may affect whether *x* mode can be used. *SPP* mode is most likely to work.

No other combinations are supported, and a port cannot be changed from input to output once the driver is installed. The [Parport Block Diagram](#) shows two block diagrams, one showing the driver when the data group is configured for output, and one showing it configured for input. For *x* mode, refer to the pin listing of `halcmd show pin` for pin direction assignment.

The parport driver can control up to 8 ports (defined by `MAX_PORTS` in `hal_parport.c`). The ports are numbered starting at zero.

10.1.1 Installing

```
loadrt hal_parport cfg="<config-string>"
```

Using the Port Index I/O addresses below 16 are treated as port indexes. This is the simplest way to install the parport driver and cooperates with the Linux `parport_pc` driver if it is loaded. This will use the address Linux has detected for parport 0.

```
loadrt hal_parport cfg="0"
```

Using the Port Address The configure string consists of a hex port address, followed by an optional direction, repeated for each port. The direction is *in*, *out*, or *x* and determines the direction of the physical pins 2 through 9, and whether to create input HAL pins for the physical control pins. If the direction is not specified, the data group defaults to output. For example:

```
loadrt hal_parport cfg="0x278 0x378 in 0x20A0 out"
```

This example installs drivers for one port at 0x0278, with pins 2-9 as outputs (by default, since neither *in* nor *out* was specified), one at 0x0378, with pins 2-9 as inputs, and one at 0x20A0, with pins 2-9 explicitly specified as outputs. Note that you must know the base address of the parallel port to properly configure the driver. For ISA bus ports, this is usually not a problem, since the port is almost always at a *well known* address, like 0278 or 0378 which is typically configured in the system BIOS. The address for a PCI card is usually shown in `lspci -v` in an *I/O ports* line, or in the kernel message log after executing `sudo modprobe -a parport_pc`. There is no default address; if `<config-string>` does not contain at least one address, it is an error.

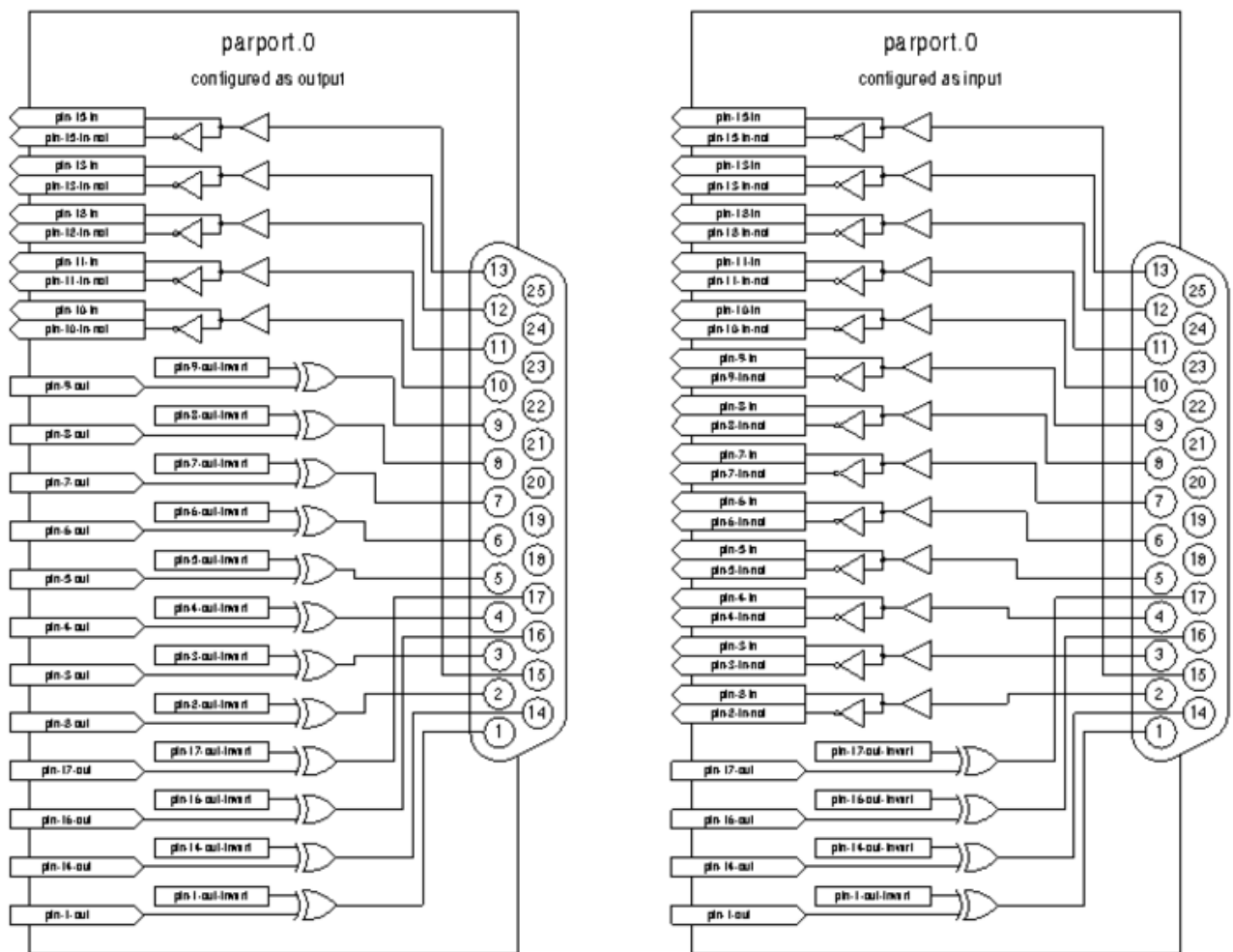

Figure 10.1: Parport Block Diagram

10.1.2 Pins

- `parport.<p>.pin-<n>-out` (bit) Drives a physical output pin.
- `parport.<p>.pin-<n>-in` (bit) Tracks a physical input pin.
- `parport.<p>.pin-<n>-in-not` (bit) Tracks a physical input pin, but inverted.

For each pin, $\langle p \rangle$ is the port number, and $\langle n \rangle$ is the physical pin number in the 25 pin D-shell connector.

For each physical output pin, the driver creates a single HAL pin, for example: *parport.0.pin-14-out*.

Pins 2 through 9 are part of the data group and are output pins if the port is defined as an output port. (Output is the default.) Pins 1, 14, 16, and 17 are outputs in all modes. These HAL pins control the state of the corresponding physical pins.

For each physical input pin, the driver creates two HAL pins, for example: *parport.0.pin-12-in* and *parport.0.pin-12-in-not*.

Pins 10, 11, 12, 13, and 15 are always input pins. Pins 2 through 9 are input pins only if the port is defined as an input port. The *-in* HAL pin is TRUE if the physical pin is high, and FALSE if the physical pin is low. The *-in-not* HAL pin is inverted—it is FALSE if the physical pin is high. By connecting a signal to one or the other, the user can determine the state of the input. In *x* mode, pins 1, 14, 16, and 17 are also input pins.

10.1.3 Parameters

- *parport.<p>.pin-<n>-out-invert* (bit) Inverts an output pin.
- *parport.<p>.pin-<n>-out-reset* (bit) (only for *out* pins) TRUE if this pin should be reset when the *-reset* function is executed.
- *parport.<p>.reset-time* (U32) The time (in nanoseconds) between a pin is set by *write* and reset by the *reset* function if it is enabled.

The *-invert* parameter determines whether an output pin is active high or active low. If *-invert* is FALSE, setting the HAL *-out* pin TRUE drives the physical pin high, and FALSE drives it low. If *-invert* is TRUE, then setting the HAL *-out* pin TRUE will drive the physical pin low.

10.1.4 Functions

- *parport.<p>.read* (funct) Reads physical input pins of port $\langle portnum \rangle$ and updates HAL *-in* and *-in-not* pins.
- *parport.read-all* (funct) Reads physical input pins of all ports and updates HAL *-in* and *-in-not* pins.
- *parport.<p>.write* (funct) Reads HAL *-out* pins of port $\langle p \rangle$ and updates that port's physical output pins.
- *parport.write-all* (funct) Reads HAL *-out* pins of all ports and updates all physical output pins.
- *parport.<p>.reset* (funct) Waits until *reset-time* has elapsed since the associated *write*, then resets pins to values indicated by *-out-invert* and *-out-invert* settings. *reset* must be later in the same thread as *write*. 'If' *-reset* is TRUE, then the *reset* function will set the pin to the value of *-out-invert*. This can be used in conjunction with *stepgen*'s *doublefreq* to produce one step per period. The [stepgen stepspace](#) for that pin must be set to 0 to enable *doublefreq*.

The individual functions are provided for situations where one port needs to be updated in a very fast thread, but other ports can be updated in a slower thread to save CPU time. It is probably not a good idea to use both an *-all* function and an individual function at the same time.

10.1.5 Common problems

If loading the module reports

```
insmod: error inserting '/home/jepler/emc2/rtlib/hal_parport.ko':
-1 Device or resource busy
```

then ensure that the standard kernel module *parport_pc* is not loaded¹ and that no other device in the system has claimed the I/O ports.

If the module loads but does not appear to function, then the port address is incorrect or the *probe_parport* module is required.

¹ In the LinuxCNC packages for Ubuntu, the file */etc/modprobe.d/emc2* generally prevents *parport_pc* from being automatically loaded.

10.1.6 Using DoubleStep

To setup DoubleStep on the parallel port you must add the function `parport.n.reset` after `parport.n.write` and configure `stepspace` to 0 and the reset time wanted. So that step can be asserted on every period in HAL and then toggled off by `parport` after being asserted for time specified by `parport.n.reset-time`.

For example:

```
loadrt hal_parport cfg="0x378 out"
setp parport.0.reset-time 5000
loadrt stepgen step_type=0,0,0
addf parport.0.read base-thread
addf stepgen.make-pulses base-thread
addf parport.0.write base-thread
addf parport.0.reset base-thread
addf stepgen.capture-position servo-thread
...
setp stepgen.0.steplen 1
setp stepgen.0.stepspace 0
```

More information on DoubleStep can be found on the [wiki](#).

10.2 probe_parport

In modern PCs, the parallel port may require plug and play (PNP) configuration before it can be used. The `probe_parport` module performs configuration of any PNP ports present, and should be loaded before `hal_parport`. On machines without PNP ports, it may be loaded but has no effect.

10.2.1 Installing

```
loadrt probe_parport
loadrt hal_parport ...
```

If the Linux kernel prints a message similar to

```
parport: PnPBIOS parport detected.
```

when the `parport_pc` module is loaded (`sudo modprobe -a parport_pc`; `sudo rmmmod parport_pc`) then use of this module is probably required.

Chapter 11

HAL Examples

All of these examples assume you are starting with a stepconf based configuration and have two threads base-thread and servo-thread. The stepconf wizard will create an empty custom.hal and a custom_postgui.hal file. The custom.hal file will be loaded after the configuration HAL file and the custom_postgui.hal file is loaded after the GUI has been loaded.

11.1 Manual Toolchange

In this example it is assumed that you're *rolling your own* configuration and wish to add the HAL Manual Toolchange window. The HAL Manual Toolchange is primarily useful if you have presettable tools and you store the offsets in the tool table. If you need to touch off for each tool change then it is best just to split up your g code. To use the HAL Manual Toolchange window you basically have to load the hal_manualtoolchange component then send the iocontrol *tool change* to the hal_manualtoolchange *change* and send the hal_manualtoolchange *changed* back to the iocontrol *tool changed*.

This is an example of manual toolchange *with* the HAL Manual Toolchange component:

```
loadusr -W hal_manualtoolchange
net tool-change iocontrol.0.tool-change => hal_manualtoolchange.change
net tool-changed iocontrol.0.tool-changed <= hal_manualtoolchange.changed
net tool-number iocontrol.0.tool-prep-number => hal_manualtoolchange.number
net tool-prepare-loopback iocontrol.0.tool-prepare => iocontrol.0.tool-prepared
```

This is an example of manual toolchange *without* the HAL Manual Toolchange component:

```
net tool-number <= iocontrol.0.tool-prep-number
net tool-change-loopback iocontrol.0.tool.-change => iocontrol.0.tool-changed
net tool-prepare-loopback iocontrol.0.tool-prepare => iocontrol.0.tool-prepared
```

11.2 Compute Velocity

This example uses *ddt*, *mult2* and *abs* to compute the velocity of a single axis. For more information on the real time components see the man pages or the Realtime Components section ([\[sec:Realtime-Components\]](#)).

The first thing is to check your configuration to make sure you are not using any of the real time components all ready. You can do this by opening up the HAL Configuration window and look for the components in the pin section. If you are then find the .hal file that they are being loaded in and increase the counts and adjust the instance to the correct value. Add the following to your custom.hal file.

Load the realtime components.

```
loadrt ddt count=1
loadrt mult2 count=1
loadrt abs count=1
```

Add the functions to a thread so it will get updated.

```
addf ddt.0 servo-thread
addf mult2.0 servo-thread
addf abs.0 servo-thread
```

Make the connections.

```
setp mult2.in1 60
net xpos-cmd ddt.0.in
net X-IPS mult2.0.in0 <= ddt.0.out
net X-ABS abs.0.in <= mult2.0.out
net X-IPM abs.0.out
```

In this last section we are setting the mult2.0.in1 to 60 to convert the inch per second to inch per minute that we get from the ddt.0.out.

The xpos-cmd sends the commanded position to the ddt.0.in. The ddt computes the derivative of the change of the input.

The ddt2.0.out is multiplied by 60 to give IPM.

The mult2.0.out is sent to the abs to get the absolute value.

The following figure shows the result when the X axis is moving at 15 IPM in the minus direction. Notice that we can get the absolute value from either the abs.0.out pin or the X-IPM signal.

The screenshot shows the HAL Configuration window with a tree view on the left and a table of signal values on the right. The tree view shows the following structure:

- Components
 - Pins
 - abs
 - 0
 - in
 - out
 - sign
 - axis
 - axisui
 - ddt
 - 0
 - in
 - out
 - hal_manualtoolchange
 - iocontrol
 - motion
 - mult2
 - 0
 - in0
 - in1
 - out
 - parport
 - pwmgen
 - stepgen
 - Parameters
 - Signals
 - X
 - X-ABS
 - X-IPM
 - X-IPS

The table on the right shows the following values:

SHOW	WATCH
-0.25	ddt.0.out
-15	mult2.0.out
15	abs.0.out
-15	X-ABS
15	X-IPM
-0.25	X-IPS

Figure 11.1: Velocity Example

11.3 Soft Start

This example shows how the HAL components *lowpass*, *limit2* or *limit3* can be used to limit how fast a signal changes.

In this example we have a servo motor driving a lathe spindle. If we just used the commanded spindle speeds on the servo it will try to go from present speed to commanded speed as fast as it can. This could cause a problem or damage the drive. To slow the rate of change we can send the motion.spindle-speed-out through a limiter before the PID, so that the PID command value changes to new settings more slowly.

Three built-in components that limit a signal are:

- *limit2* limits the range and first derivative of a signal.
- *limit3* limits the range, first and second derivatives of a signal.
- *lowpass* uses an exponentially-weighted moving average to track an input signal.

To find more information on these HAL components check the man pages.

Place the following in a text file called `softstart.hal`. If you're not familiar with Linux place the file in your home directory.

```
loadrt threads period1=1000000 name1=thread
loadrt siggen
loadrt lowpass
loadrt limit2
loadrt limit3
net square siggen.0.square => lowpass.0.in limit2.0.in limit3.0.in
net lowpass <= lowpass.0.out
net limit2 <= limit2.0.out
net limit3 <= limit3.0.out
setp siggen.0.frequency .1
setp lowpass.0.gain .01
setp limit2.0.maxv 2
setp limit3.0.maxv 2
setp limit3.0.maxa 10
addf siggen.0.update thread
addf lowpass.0 thread
addf limit2.0 thread
addf limit3.0 thread
start
loadusr halscope
```

Open a terminal window and run the file with the following command.

```
halrun -I softstart.hal
```

When the HAL Oscilloscope first starts up click *OK* to accept the default thread.

Next you have to add the signals to the channels. Click on channel 1 then select *square* from the Signals tab. Repeat for channels 2-4 and add *lowpass*, *limit2*, and *limit3*.

Next to set up a trigger signal click on the Source None button and select *square*. The button will change to Source Chan 1.

Next click on Single in the Run Mode radio buttons box. This will start a run and when it finishes you will see your traces.

To separate the signals so you can see them better click on a channel then use the Pos slider in the Vertical box to set the positions.

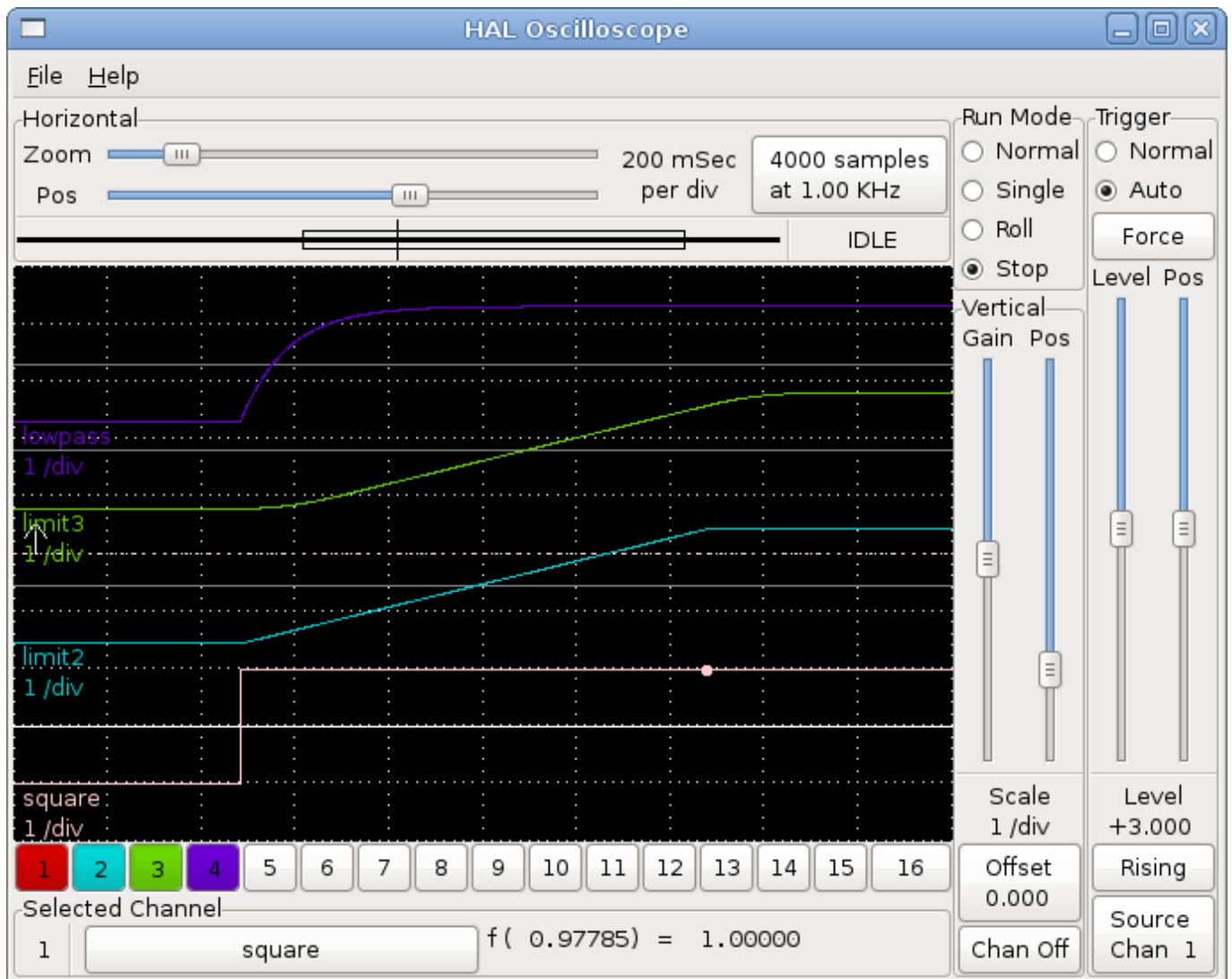

Figure 11.2: Softstart

To see the effect of changing the set point values of any of the components you can change them in the terminal window. To see what different gain settings do for lowpass just type the following in the terminal window and try different settings.

```
setp lowpass.0.gain *.01
```

After changing a setting run the oscilloscope again to see the change.

When you're finished type *exit* in the terminal window to shut down halrun and close the halscope. Don't close the terminal window with halrun running as it might leave some things in memory that could prevent EMC from loading.

For more information on Halscope see the HAL manual.

11.4 Stand Alone HAL

In some cases you might want to run a GladeVCP screen with just HAL. For example say you had a stepper driven device that all you need is to run a stepper motor. A simple *Start/Stop* interface is all you need for your application so no need to load up and configure a full blown CNC application.

In the following example we have created a simple GladeVCP panel with one

Basic Syntax

```
# load the winder.glade GUI and name it winder
loadusr -Wn winder gladevcp -c winder -u handler.py winder.glade

# load realtime components
loadrt threads name1=fast period1=50000 fp1=0 name2=slow period2=1000000
loadrt stepgen step_type=0 ctrl_type=v
loadrt hal_parport cfg="0x378 out"

# add functions to threads
addf stepgen.make-pulses fast
addf stepgen.update-freq slow
addf stepgen.capture-position slow
addf parport.0.read fast
addf parport.0.write fast

# make hal connections
net winder-step parport.0.pin-02-out <= stepgen.0.step
net winder-dir parport.0.pin-03-out <= stepgen.0.dir
net run-stepgen stepgen.0.enable <= winder.start_button

# start the threads
start

# comment out the following lines while testing and use the interactive
# option halrun -I -f start.hal to be able to show pins etc.

# wait until the gladevcp GUI named winder terminates
waitusr winder

# stop HAL threads
stop

# unload HAL all components before exiting
unloadrt all
```

Chapter 12

HAL User Interface

12.1 Introduction

Halui is a HAL based user interface for LinuxCNC, it connects HAL pins to NML commands. Most of the functionality (buttons, indicators etc.) that is provided by a traditional GUI (mini, Axis, etc.), is provided by HAL pins in Halui.

The easiest way to add halui is to add the following to the [HAL] section of the ini file.

```
HALUI = halui
```

An alternate way to invoke it is to include the following in your .hal file. Make sure you use the actual path to your ini file.

```
loadusr halui -ini /path/to/inifile.ini
```

12.2 Halui pin reference

ABORT

- *halui.abort* (bit, in) - pin to send an abort message (clears out most errors)

AXIS

- *halui.axis.n.pos-commanded* (float, out) - Commanded axis position in machine coordinates
- *halui.axis.n.pos-feedback* (float, out) - Feedback axis position in machine coordinates
- *halui.axis.n.pos-relative* (float, out) - Commanded axis position in relative coordinates

E-STOP

- *halui.estop.activate* (bit, in) - pin for requesting E-Stop
- *halui.estop.is-activated* (bit, out) - indicates E-stop reset
- *halui.estop.reset* (bit, in) - pin for requesting E-Stop reset

FEED OVERRIDE

- *halui.feed-override.count-enable* (bit, in) - must be true for *counts* or *direct-value* to work.
-

- *halui.feed-override.counts* (s32, in) - counts * scale = FO percentage. Can be used with an encoder or *direct-value*.
- *halui.feed-override.decrease* (bit, in) - pin for decreasing the FO (=-scale)
- *halui.feed-override.increase* (bit, in) - pin for increasing the FO (+=scale)
- *halui.feed-override.direct-value* (bit, in) - false when using encoder to change counts, true when setting counts directly. The *count-enable* pin must be true.
- *halui.feed-override.scale* (float, in) - pin for setting the scale for increase and decrease of *feed-override*.
- *halui.feed-override.value* (float, out) - current FO value

MIST

- *halui.mist.is-on* (bit, out) - indicates mist is on
- *halui.mist.off* (bit, in) - pin for requesting mist off
- *halui.mist.on* (bit, in) - pin for requesting mist on

FLOOD

- *halui.flood.is-on* (bit, out) - indicates flood is on
- *halui.flood.off* (bit, in) - pin for requesting flood off
- *halui.flood.on* (bit, in) - pin for requesting flood on

HOMING

- *halui.home-all* (bit, in) - pin for requesting all axis to home. This pin will only be there if HOME_SEQUENCE is set in the ini file.

Jog <n> is a number between 0 and 8 and *selected*.

- *halui.jog-deadband* (float, in) - deadband for analog jogging (smaller jogging speed requests are not performed)
- *halui.jog-speed* (float, in) - pin for setting jog speed for minus/plus jogging
- *halui.jog.<n>.analog* (float, in) - analog velocity input for jogging (useful with joysticks or other analog devices)
- *halui.jog.<n>.increment* (float,in) - pin for setting the jog increment for axis <n> when using increment-minus or increment-plus to jog.
- *halui.jog.<n>.increment-minus* (bit, in) - pin for moving the <n> axis one increment in the minus direction for each off to on transition.
- *halui.jog.<n>.increment-plus* (bit, in) - pin for moving the <n> axis one increment in the plus direction for each off to on transition.
- *halui.jog.<n>.minus* (bit, in) - pin for jogging axis <n> in negative direction at the *halui.jog.speed* velocity
- *halui.jog.<n>.plus* (bit, in) - pin for jogging axis <n> in positive direction at the *halui.jog.speed* velocity
- *halui.jog.selected.increment* (float,in) - pin for setting the jog increment for the selected axis when using increment-minus or increment-plus to jog.
- *halui.jog.selected.increment-minus* (bit, in) - pin for moving the selected axis one increment in the minus direction for each off to on transition.
- *halui.jog.selected.increment-plus* (bit, in) - pin for moving the selected axis one increment in the plus direction for each off to on transition.

- *halui.jog.selected.minus* (bit, in) - pin for jogging the selected axis in negative direction at the *halui.jog.speed* velocity
- *halui.jog.selected.plus* (bit, in) - pin for jogging the selected axis in positive direction at the *halui.jog.speed* velocity

Joint <n> is a number between 0 and 8 and *selected*.

- *halui.joint.<n>.has-fault* (bit, out) - status pin telling the joint has a fault
- *halui.joint.<n>.home* (bit, in) - pin for homing the specific joint
- *halui.joint.<n>.is-homed* (bit, out) - status pin telling that the joint is homed
- *halui.joint.<n>.is-selected bit* (bit, out) - status pin a joint is selected* internal halui
- *halui.joint.<n>.on-hard-max-limit* (bit, out) - status pin telling joint <n> is on the positive hardware limit switch
- *halui.joint.<n>.on-hard-min-limit* (bit, out) - status pin telling joint <n> is on the negative hardware limit switch
- *halui.joint.<n>.on-soft-max-limit* (bit, out) - status pin telling joint <n> is at the positive software limit
- *halui.joint.<n>.on-soft-min-limit* (bit, out) - status pin telling joint <n> is at the negative software limit
- *halui.joint.<n>.select* (bit, in) - select joint (0..8) - internal halui
- *halui.joint.<n>.unhome* (bit, in) - unhomes this joint
- *halui.joint.selected* (u32, out) - selected joint (0..8) - internal halui
- *halui.joint.selected.has-fault* (bit, out) - status pin telling that the joint <n> has a fault
- *halui.joint.selected.home* (bit, in) - pin for homing the selected joint
- *halui.joint.selected.is-homed* (bit, out) - status pin telling that the selected joint is homed
- *halui.joint.selected.on-hard-max-limit* (bit, out) - status pin telling that the selected joint is on the positive hardware limit
- *halui.joint.selected.on-hard-min-limit* (bit, out) - status pin telling that the selected joint is on the negative hardware limit
- *halui.joint.selected.on-soft-max-limit* (bit, out) - status pin telling that the selected joint is on the positive software limit
- *halui.joint.selected.on-soft-min-limit* (bit, out) - status pin telling that the selected joint is on the negative software limit
- *halui.joint.selected.unhome* (bit, in) - pin for unhoming the selected joint.

LUBE

- *halui.lube.is-on* (bit, out) - indicates lube is on
- *halui.lube.off* (bit, in) - pin for requesting lube off
- *halui.lube.on* (bit, in) - pin for requesting lube on

MACHINE

- *halui.machine.is-on* (bit, out) - indicates machine on
- *halui.machine.off* (bit, in) - pin for requesting machine off
- *halui.machine.on* (bit, in) - pin for requesting machine on

Max Velocity The maximum linear velocity can be adjusted from 0 to the *MAX_VELOCITY* that is set in the [TRAJ] section of the ini file.

- *halui.max-velocity.count-enable* (bit, in) - must be true for *counts* or *direct-value* to work.

- *halui.max-velocity.counts* (s32, in) - counts * scale = MV percentage. Can be used with an encoder or *direct-value*.
- *halui.max-velocity.direct-value* (bit, in) - false when using encoder to change counts, true when setting counts directly. The *count-enable* pin must be true.
- *halui.max-velocity.decrease* (bit, in) - pin for decreasing max velocity
- *halui.max-velocity.increase* (bit, in) - pin for increasing max velocity
- *halui.max-velocity.scale* (float, in) - the amount applied to the current maximum velocity with each transition from off to on of the increase or decrease pin in machine units per second.
- *halui.max-velocity.value* (float, out) - is the maximum linear velocity in machine units per second.

MDI

Sometimes the user wants to add more complicated tasks to be performed by the activation of a HAL pin. This is possible using the following MDI commands scheme:

- The MDI_COMMAND is added to the ini file in the [HALUI] section.

```
[HALUI]
MDI_COMMAND = G0 X0
```

- When halui starts it will read the MDI_COMMAND fields in the ini, and export pins from 00 to the number of MDI_COMMAND's found in the ini up to a maximum of 64 commands.
- *halui.mdi-command-<nn>* (bit, in) - halui will try to send the MDI command defined in the ini. This will not always succeed, depending on the operating mode LinuxCNC is in (e.g. while in AUTO halui can't successfully send MDI commands). If the command succeeds then it will place LinuxCNC in the MDI mode and then back to Manual mode.

JOINT SELECTION

- *halui.joint.select* (u32, in) - select joint (0..8) - internal halui
- *halui.joint.selected* (u32, out) - joint (0..8) selected* internal halui
- *halui.joint.x.select bit* (bit, in) - pins for selecting a joint* internal halui
- *halui.joint.x.is-selected bit* (bit, out) - indicates joint selected* internal halui

MODE

- *halui.mode.auto* (bit, in) - pin for requesting auto mode
- *halui.mode.is-auto* (bit, out) - indicates auto mode is on
- *halui.mode.is-joint* (bit, out) - indicates joint by joint jog mode is on
- *halui.mode.is-manual* (bit, out) - indicates manual mode is on
- *halui.mode.is-mdi* (bit, out) - indicates mdi mode is on
- *halui.mode.is-teleop* (bit, out) - indicates coordinated jog mode is on
- *halui.mode.joint* (bit, in) - pin for requesting joint by joint jog mode
- *halui.mode.manual* (bit, in) - pin for requesting manual mode
- *halui.mode.mdi* (bit, in) - pin for requesting mdi mode
- *halui.mode.teleop* (bit, in) - pin for requesting coordinated jog mode

PROGRAM

- *halui.program.block-delete.is-on* (bit, out) - status pin telling that block delete is on
- *halui.program.block-delete.off* (bit, in) - pin for requesting that block delete is off
- *halui.program.block-delete.on* (bit, in) - pin for requesting that block delete is on
- *halui.program.is-idle* (bit, out) - status pin telling that no program is running
- *halui.program.is-paused* (bit, out) - status pin telling that a program is paused
- *halui.program.is-running* (bit, out) - status pin telling that a program is running
- *halui.program.optional-stop.is-on* (bit, out) - status pin telling that the optional stop is on
- *halui.program.optional-stop.off* (bit, in) - pin requesting that the optional stop is off
- *halui.program.optional-stop.on* (bit, in) - pin requesting that the optional stop is on
- *halui.program.pause* (bit, in) - pin for pausing a program
- *halui.program.resume* (bit, in) - pin for resuming a paused program
- *halui.program.run* (bit, in) - pin for running a program
- *halui.program.step* (bit, in) - pin for stepping in a program
- *halui.program.stop* (bit, in) - pin for stopping a program

SPINDLE OVERRIDE

- *halui.spindle-override.count-enable* (bit, in) - must be true for *counts* or *direct-value* to work.
- *halui.spindle-override.counts* (s32, in) - counts * scale = SO percentage
- *halui.spindle-override.decrease* (bit, in) - pin for decreasing the SO (-=scale)
- *halui.spindle-override.direct-value* (bit, in) - false when using encoder to change counts, true when setting counts directly. The *count-enable* pin must be true.
- *halui.spindle-override.increase* (bit, in) - pin for increasing the SO (+=scale)
- *halui.spindle-override.scale* (float, in) - pin for setting the scale on changing the SO
- *halui.spindle-override.value* (float, out) - current SO value

SPINDLE

- *halui.spindle.brake-is-on* (bit, out) - indicates brake is on
 - *halui.spindle.brake-off* (bit, in) - pin for deactivating spindle/brake
 - *halui.spindle.brake-on* (bit, in) - pin for activating spindle-brake
 - *halui.spindle.decrease* (bit, in) - decreases spindle speed
 - *halui.spindle.forward* (bit, in) - starts the spindle with CW motion
 - *halui.spindle.increase* (bit, in) - increases spindle speed
 - *halui.spindle.is-on* (bit, out) - indicates spindle is on (either direction)
 - *halui.spindle.reverse* (bit, in) - starts the spindle with a CCW motion
 - *halui.spindle.runs-backward* (bit, out) - indicates spindle is on, and in reverse
-

- *halui.spindle.runs-forward* (bit, out) - indicates spindle is on, and in forward
- *halui.spindle.start* (bit, in) - starts the spindle
- *halui.spindle.stop* (bit, in) - stops the spindle

TOOL

- *halui.tool.length-offset* (float, out) - indicates current applied tool-length-offset
 - *halui.tool.number* (u32, out) - indicates current selected tool
-

Chapter 13

Halui Examples

For any Halui examples to work you need to add the following line to the [HAL] section of the ini file.

```
HALUI = halui
```

13.1 Remote Start

To connect a remote program start button to LinuxCNC you use the `halui.program.run` pin and the `halui.mode.auto` pin. You have to insure that it is OK to run first by using the `halui.mode.is-auto` pin. You do this with an `and2` component. The following figure shows how this is done. When the Remote Run Button is pressed it is connected to both `halui.mode.auto` and `and2.0.in0`. If it is OK for auto mode the pin `halui.mode.is-auto` will be on. If both the inputs to the `and2.0` component are on the `and2.0.out` will be on and this will start the program.

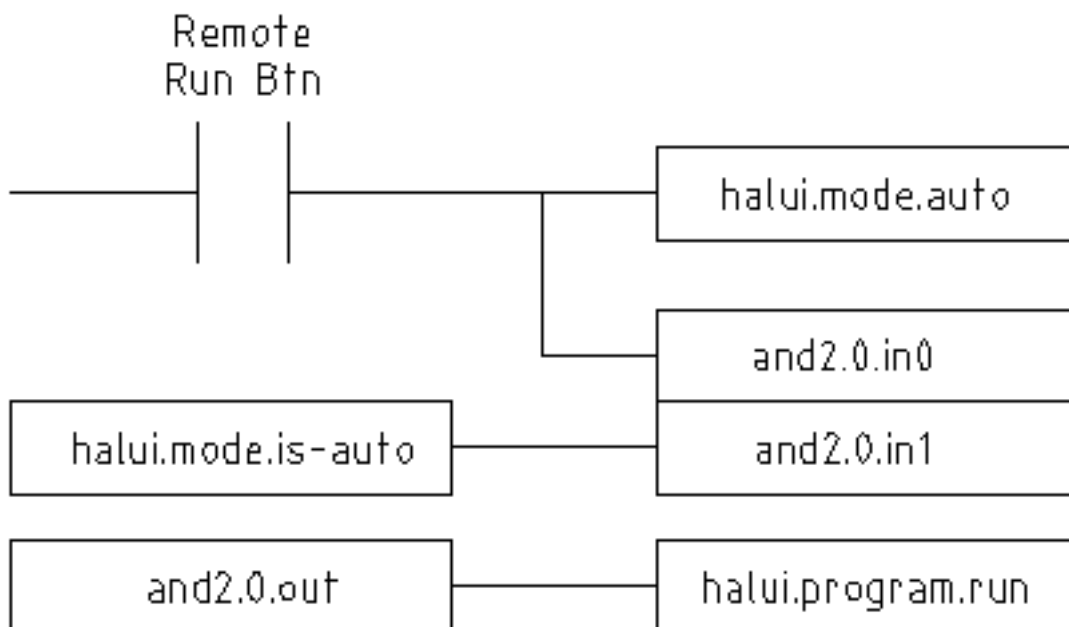

Figure 13.1: Remote Start Example

The hal commands needed to accomplish the above are:

```
net program-start-btn halui.mode.auto and2.0.in0 <= <your input pin>
net program-run-ok and2.0.in1 <= halui.mode.is-auto
net remote-program-run halui.program.run <= and2.0.out
```

Notice on line one that there are two reader pins, this can also be split up to two lines like this:

```
net program-start-btn halui.mode.auto <= <your input pin>
net program-start-btn and2.0.in0
```

13.2 Pause & Resume

This example was developed to allow LinuxCNC to move a rotary axis on a signal from an external machine. The coordination between the two systems will be provided by two Halui components:

- halui.program.is-paused
- halui.program.resume

In your customized hal file, add the following two lines that will be connected to your I/O to turn on the program pause or to resume when the external system wants LinuxCNC to continue.

```
net ispaused halui.program.is paused => "your output pin"
net resume halui.program.resume <= "your input pin"
```

Your input and output pins are connected to the pins wired to the other controller. They may be parallel port pins or any other I/O pins that you have access to.

This system works in the following way. When an M0 is encountered in your G-code, the halui.program.is-paused signal goes true. This turns on your output pin so that the external controller knows that LinuxCNC is paused.

To resume the LinuxCNC gcode program, when the external controller is ready it will make its output true. This will signal LinuxCNC that it should resume executing Gcode.

Difficulties in timing

- The "resume" input return signal should not be longer than the time required to get the g-code running again.
- The "is-paused" output should no longer be active by the time the "resume" signal ends.

These timing problems could be avoided by using ClassicLadder to activate the "is-paused" output via a monostable timer to deliver one narrow output pulse. The "resume" pulse could also be received via a monostable timer.

Chapter 14

Comp HAL Component Generator

14.1 Introduction

Writing a HAL component can be a tedious process, most of it in setup calls to *rtapi_* and *hal_* functions and associated error checking. *comp* will write all this code for you, automatically.

Compiling a HAL component is also much easier when using *comp*, whether the component is part of the LinuxCNC source tree, or outside it.

For instance, when coded in C, a simple component such as "ddt" is around 80 lines of code. The equivalent component is very short when written using the *comp* preprocessor:

Simple Comp Example

```
component ddt "Compute the derivative of the input function";
pin in float in;
pin out float out;
variable float old;
function _;
license "GPL"; // indicates GPL v2 or later
;;
float tmp = in;
out = (tmp - old) / fperiod;
old = tmp;
```

14.2 Installing

If you're working with an installed version of LinuxCNC you will need to install the development packages.

One method is to say following line in a terminal.

Installing Dev

```
sudo apt-get install linuxcnc-dev
```

Another method is to use the Synaptic Package Manager from the main Ubuntu menu to install linuxcnc-dev.

14.3 Definitions

- *component* - A component is a single real-time module, which is loaded with *halcmd loadrt*. One *.comp* file specifies one component. The component name and file name must match.

- *instance* - A component can have zero or more instances. Each instance of a component is created equal (they all have the same pins, parameters, functions, and data) but behave independently when their pins, parameters, and data have different values.
- *singleton* - It is possible for a component to be a "singleton", in which case exactly one instance is created. It seldom makes sense to write a *singleton* component, unless there can literally only be a single object of that kind in the system (for instance, a component whose purpose is to provide a pin with the current UNIX time, or a hardware driver for the internal PC speaker)

14.4 Instance creation

For a singleton, the one instance is created when the component is loaded.

For a non-singleton, the *count* module parameter determines how many numbered instances are created. If not specified, the *name* module parameter determines how many named instances are created. Otherwise, a single numbered instance is created.

14.5 Implicit Parameters

Functions are implicitly passed the *period* parameter which is the time in nanoseconds of the last period to execute the comp. Functions which use floating-point can also refer to *fperiod* which is the floating-point time in seconds, or (period*1e-9). This can be useful in comps that need the timing information.

14.6 Syntax

A *.comp* file consists of a number of declarations, followed by `;;` on a line of its own, followed by C code implementing the module's functions.

Declarations include:

- *component* HALNAME (DOC);
- *pin* PINDIRECTION TYPE HALNAME ([SIZE][MAXSIZE: CONDSIZE]) (if CONDITION) (= STARTVALUE) (DOC) ;
- *param* PARAMDIRECTION TYPE HALNAME ([SIZE][MAXSIZE: CONDSIZE]) (if CONDITION) (= STARTVALUE) (DOC) ;
- *function* HALNAME (fp | nofp) (DOC);
- *option* OPT (VALUE);
- *variable* CTYPE STARREDNAME ([SIZE]);
- *description* DOC;
- *see_also* DOC;
- *license* LICENSE;
- *author* AUTHOR;

Parentheses indicate optional items. A vertical bar indicates alternatives. Words in *CAPITALS* indicate variable text, as follows:

- *NAME* - A standard C identifier
- *STARREDNAME* - A C identifier with zero or more * before it. This syntax can be used to declare instance variables that are pointers. Note that because of the grammar, there may not be whitespace between the * and the variable name.

- **HALNAME** - An extended identifier. When used to create a HAL identifier, any underscores are replaced with dashes, and any trailing dash or period is removed, so that "this_name_" will be turned into "this-name", and if the name is "_", then a trailing period is removed as well, so that "function_" gives a HAL function name like "component.<num>" instead of "component.<num>."

If present, the prefix *hal_* is removed from the beginning of the component name when creating pins, parameters and functions. In the HAL identifier for a pin or parameter, # denotes an array item, and must be used in conjunction with a [SIZE] declaration. The hash marks are replaced with a 0-padded number with the same length as the number of # characters.

When used to create a C identifier, the following changes are applied to the HALNAME:

1. Any "#" characters, and any ".", "_" or "-" characters immediately before them, are removed.
2. Any remaining "." and "-" characters are replaced with "_".
3. Repeated "_" characters are changed to a single "\" character.

A trailing "_" is retained, so that HAL identifiers which would otherwise collide with reserved names or keywords (e.g., *min*) can be used.

HALNAME	C Identifier	HAL Identifier
x_y_z	x_y_z	x-y-z
x-y.z	x_y_z	x-y.z
x_y_z_	x_y_z_	x-y-z
x.##.y	x_y(MM)	x.MM.z
x.##	x(MM)	x.MM

- **if CONDITION** - An expression involving the variable *personality* which is nonzero when the pin or parameter should be created
- **SIZE** - A number that gives the size of an array. The array items are numbered from 0 to *SIZE*-1.
- **MAXSIZE : CONDSIZE** - A number that gives the maximum size of the array followed by an expression involving the variable *personality* and which always evaluates to less than *MAXSIZE*. When the array is created its size will be *CONDSIZE*.
- **DOC** - A string that documents the item. String can be a C-style "double quoted" string, like:

```
"Selects the desired edge: TRUE means falling, FALSE means rising"
```

or a Python-style "triple quoted" string, which may include embedded newlines and quote characters, such as:

```
"""The effect of this parameter, also known as "the orb of zot",
will require at least two paragraphs to explain.

Hopefully these paragraphs have allowed you to understand "zot"
better."""
```

The documentation string is in "groff -man" format. For more information on this markup format, see *groff_man(7)*. Remember that comp interprets backslash escapes in strings, so for instance to set the italic font for the word *example*, write:

```
"\\fIexample\\fB"
```

- **TYPE** - One of the HAL types: *bit*, *signed*, *unsigned*, or *float*. The old names *s32* and *u32* may also be used, but *signed* and *unsigned* are preferred.
- **PINDIRECTION** - One of the following: *in*, *out*, or *io*. A component sets a value for an *out* pin, it reads a value from an *in* pin, and it may read or set the value of an *io* pin.
- **PARAMDIRECTION** - One of the following: *r* or *rw*. A component sets a value for a *r* parameter, and it may read or set the value of a *rw* parameter.
- **STARTVALUE** - Specifies the initial value of a pin or parameter. If it is not specified, then the default is 0 or *FALSE*, depending on the type of the item.

14.6.1 HAL functions

- *fp* - Indicates that the function performs floating-point calculations.
- *noffp* - Indicates that it only performs integer calculations. If neither is specified, *fp* is assumed. Neither *comp* nor *gcc* can detect the use of floating-point calculations in functions that are tagged *noffp*, but use of such operations results in undefined behavior.

14.6.2 Options

The currently defined options are:

- *option singleton yes* - (default: no) Do not create a *count* module parameter, and always create a single instance. With *singleton*, items are named *component-name.item-name* and without *singleton*, items for numbered instances are named *component-name.<num>.item-name*.
- *option default_count number* - (default: 1) Normally, the module parameter *count* defaults to 1. If specified, the *count* will default to this value instead.
- *option count_function yes* - (default: no) Normally, the number of instances to create is specified in the module parameter *count*; if *count_function* is specified, the value returned by the function *int get_count(void)* is used instead, and the *count* module parameter is not defined.
- *option rtapi_app no* - (default: yes) Normally, the functions *rtapi_app_main* and *rtapi_app_exit* are automatically defined. With *option rtapi_app no*, they are not, and must be provided in the C code. When implementing your own *rtapi_app_main*, call the function *int export(char *prefix, long extra_arg)* to register the pins, parameters, and functions for *prefix*.
- *option data TYPE* - (default: none) **deprecated** If specified, each instance of the component will have an associated data block of type *TYPE* (which can be a simple type like *float* or the name of a type created with *typedef*). In new components, *variable* should be used instead.
- *option extra_setup yes* - (default: no) If specified, call the function defined by *EXTRA_SETUP* for each instance. If using the automatically defined *rtapi_app_main*, *extra_arg* is the number of this instance.
- *option extra_cleanup yes* - (default: no) If specified, call the function defined by *EXTRA_CLEANUP* from the automatically defined *rtapi_app_exit*, or if an error is detected in the automatically defined *rtapi_app_main*.
- *option userspace yes* - (default: no) If specified, this file describes a userspace component, rather than a real one. A userspace component may not have functions defined by the *function* directive. Instead, after all the instances are constructed, the C function *user_mainloop()* is called. When this function returns, the component exits. Typically, *user_mainloop()* will use *FOR_ALL_INSTS()* to perform the update action for each instance, then sleep for a short time. Another common action in *user_mainloop()* may be to call the event handler loop of a GUI toolkit.
- *option userinit yes* - (default: no) This option is ignored if the option *userspace* (see above) is set to *no*. If *userinit* is specified, the function *userinit(argc,argv)* is called before *rtapi_app_main()* (and thus before the call to *hal_init()*). This function may process the commandline arguments or take other actions. Its return type is *void*; it may call *exit()* if it wishes to terminate rather than create a HAL component (for instance, because the commandline arguments were invalid).

If an option's VALUE is not specified, then it is equivalent to specifying *option ... yes*. The result of assigning an inappropriate value to an option is undefined. The result of using any other option is undefined.

14.6.3 License and Authorship

- *LICENSE* - Specify the license of the module for the documentation and for the *MODULE_LICENSE()* module declaration. For example, to specify that the module's license is GPL v2 or later,

```
license "GPL"; // indicates GPL v2 or later
```

For additional information on the meaning of `MODULE_LICENSE()` and additional license identifiers, see `<linux/module.h>`. or the manual page `rtapi_module_param(3)`

This declaration is required.

- *AUTHOR* - Specify the author of the module for the documentation.

14.6.4 Per-instance data storage

- *variable CTYPE STARREDNAME;*
- *variable CTYPE STARREDNAME[SIZE];*
- *variable CTYPE STARREDNAME = DEFAULT;*
- *variable CTYPE STARREDNAME[SIZE] = DEFAULT;*

Declare a per-instance variable *STARREDNAME* of type *CTYPE*, optionally as an array of *SIZE* items, and optionally with a default value *DEFAULT*. Items with no *DEFAULT* are initialized to all-bits-zero. *CTYPE* is a simple one-word C type, such as *float*, *u32*, *s32*, *int*, etc. Access to array variables uses square brackets.

If a variable is to be of a pointer type, there may not be any space between the "*" and the variable name. Therefore, the following is acceptable:

```
variable int *example;
```

but the following are not:

```
variable int* badexample;
variable int * badexample;
```

14.6.5 Comments

C++-style one-line comments (`//...`) and

C-style multi-line comments (`/* ... */`) are both supported in the declaration section.

14.7 Restrictions

Though HAL permits a pin, a parameter, and a function to have the same name, comp does not.

Variable and function names that can not be used or are likely to cause problems include:

- Anything beginning with `_comp`.
- *comp_id*
- *fperiod*
- *rtapi_app_main*
- *rtapi_app_exit*
- *extra_setup*
- *extra_cleanup*

14.8 Convenience Macros

Based on the items in the declaration section, *comp* creates a C structure called `struct __comp_state`. However, instead of referring to the members of this structure (e.g., `*(inst->name)`), they will generally be referred to using the macros below. The details of `struct __comp_state` and these macros may change from one version of *comp* to the next.

- *FUNCTION(name)* - Use this macro to begin the definition of a realtime function which was previously declared with *function NAME*. The function includes a parameter *period* which is the integer number of nanoseconds between calls to the function.
- *EXTRA_SETUP()* - Use this macro to begin the definition of the function called to perform extra setup of this instance. Return a negative Unix *errno* value to indicate failure (e.g., *return -EBUSY* on failure to reserve an I/O port), or 0 to indicate success.
- *EXTRA_CLEANUP()* - Use this macro to begin the definition of the function called to perform extra cleanup of the component. Note that this function must clean up all instances of the component, not just one. The "pin_name", "parameter_name", and "data" macros may not be used here.
- *pin_name* or *parameter_name* - For each pin *pin_name* or param *parameter_name* there is a macro which allows the name to be used on its own to refer to the pin or parameter. When *pin_name* or *parameter_name* is an array, the macro is of the form *pin_name(idx)* or *param_name(idx)* where *idx* is the index into the pin array. When the array is a variable-sized array, it is only legal to refer to items up to its *condsize*.

When the item is a conditional item, it is only legal to refer to it when its *condition* evaluated to a nonzero value.

- *variable_name* - For each variable *variable_name* there is a macro which allows the name to be used on its own to refer to the variable. When *variable_name* is an array, the normal C-style subscript is used: *variable_name[idx]*
- *data* - If "option data" is specified, this macro allows access to the instance data.
- *fperiod* - The floating-point number of seconds between calls to this realtime function.
- *FOR_ALL_INSTS() { . . . }* - For userspace components. This macro iterates over all the defined instances. Inside the body of the loop, the *pin_name*, *parameter_name*, and *data* macros work as they do in realtime functions.

14.9 Components with one function

If a component has only one function and the string "FUNCTION" does not appear anywhere after `;;`, then the portion after `;;` is all taken to be the body of the component's single function. See the [Simple Comp](#) for an example of this.

14.10 Component Personality

If a component has any pins or parameters with an "if condition" or "[maxsize : condsized]", it is called a component with *personality*. The *personality* of each instance is specified when the module is loaded. *Personality* can be used to create pins only when needed. For instance, *personality* is used in the *logic* component, to allow for a variable number of input pins to each logic gate and to allow for a selection of any of the basic boolean logic functions *and*, *or*, and *xor*.

14.11 Compiling

Place the *.comp* file in the source directory `linuxcnc/src/hal/components` and re-run *make*. *Comp* files are automatically detected by the build system.

If a *.comp* file is a driver for hardware, it may be placed in `linuxcnc/src/hal/components` and will be built unless LinuxCNC is configured as a userspace simulator.

14.12 Compiling realtime components outside the source tree

`comp` can process, compile, and install a realtime component in a single step, placing `rtexample.ko` in the LinuxCNC realtime module directory:

```
comp --install rtexample.comp
```

Or, it can process and compile in one step, leaving `example.ko` (or `example.so` for the simulator) in the current directory:

```
comp --compile rtexample.comp
```

Or it can simply process, leaving `example.c` in the current directory:

```
comp rtexample.comp
```

`comp` can also compile and install a component written in C, using the `--install` and `--compile` options shown above:

```
comp --install rtexample2.c
```

man-format documentation can also be created from the information in the declaration section:

```
comp --document rtexample.comp
```

The resulting manpage, `example.9` can be viewed with

```
man ./example.9
```

or copied to a standard location for manual pages.

14.13 Compiling userspace components outside the source tree

`comp` can process, compile, install, and document userspace components:

```
comp usrexample.comp
comp --compile usrexample.comp
comp --install usrexample.comp
comp --document usrexample.comp
```

This only works for `.comp` files, not for `.c` files.

14.14 Examples

14.14.1 constant

Note that the declaration "function `_`" creates functions named "constant.0", etc. The file name must match the component name.

```
component constant;
pin out float out;
param r float value = 1.0;
function _;
license "GPL"; // indicates GPL v2 or later
;;
FUNCTION(_) { out = value; }
```

14.14.2 sincos

This component computes the sine and cosine of an input angle in radians. It has different capabilities than the "sine" and "cosine" outputs of siggen, because the input is an angle, rather than running freely based on a "frequency" parameter.

The pins are declared with the names *sin_* and *cos_* in the source code so that they do not interfere with the functions *sin()* and *cos()*. The HAL pins are still called *sincos.<num>.sin*.

```
component sincos;
pin out float sin_;
pin out float cos_;
pin in float theta;
function _;
license "GPL"; // indicates GPL v2 or later
;;
#include <rtapi_math.h>
FUNCTION(_) { sin_ = sin(theta); cos_ = cos(theta); }
```

14.14.3 out8

This component is a driver for a *fictional* card called "out8", which has 8 pins of digital output which are treated as a single 8-bit value. There can be a varying number of such cards in the system, and they can be at various addresses. The pin is called *out_* because *out* is an identifier used in *<asm/io.h>*. It illustrates the use of *EXTRA_SETUP* and *EXTRA_CLEANUP* to request an I/O region and then free it in case of error or when the module is unloaded.

```
component out8;
pin out unsigned out_ "Output value; only low 8 bits are used";
param r unsigned ioaddr;

function _;

option count_function;
option extra_setup;
option extra_cleanup;
option constructable no;

license "GPL"; // indicates GPL v2 or later
;;
#include <asm/io.h>

#define MAX 8
int io[MAX] = {0,};
RTAPI_MP_ARRAY_INT(io, MAX, "I/O addresses of out8 boards");

int get_count(void) {
    int i = 0;
    for(i=0; i<MAX && io[i]; i++) { /* Nothing */ }
    return i;
}

EXTRA_SETUP() {
    if(!rtapi_request_region(io[extra_arg], 1, "out8")) {
        // set this I/O port to 0 so that EXTRA_CLEANUP does not release the IO
        // ports that were never requested.
        io[extra_arg] = 0;
        return -EBUSY;
    }
    ioaddr = io[extra_arg];
    return 0; }
```

```

EXTRA_CLEANUP() {
    int i;
    for(i=0; i < MAX && io[i]; i++) {
        rtapi_release_region(io[i], 1);
    }
}

FUNCTION(_) { outb(out_, ioaddr); }

```

14.14.4 hal_loop

```

component hal_loop;
pin out float example;

```

This fragment of a component illustrates the use of the *hal_* prefix in a component name. *loop* is the name of a standard Linux kernel module, so a *loop* component might not successfully load if the Linux *loop* module was also present on the system.

When loaded, *halcmd show comp* will show a component called *hal_loop*. However, the pin shown by *halcmd show pin* will be *loop.0.example*, not *hal-loop.0.example*.

14.14.5 arraydemo

This realtime component illustrates use of fixed-size arrays:

```

component arraydemo "4-bit Shift register";
pin in bit in;
pin out bit out-# [4];
function _ nofp;
license "GPL"; // indicates GPL v2 or later
;;
int i;
for(i=3; i>0; i--) out(i) = out(i-1);
out(0) = in;

```

14.14.6 rand

This userspace component changes the value on its output pin to a new random value in the range (0,1) about once every 1ms.

```

component rand;
option userspace;

pin out float out;
license "GPL"; // indicates GPL v2 or later
;;
#include <unistd.h>

void user_mainloop(void) {
    while(1) {
        usleep(1000);
        FOR_ALL_INSTS() out = drand48();
    }
}

```

14.14.7 logic

This realtime component shows how to use "personality" to create variable-size arrays and optional pins.

```
component logic "LinuxCNC HAL component providing experimental logic functions";
pin in bit in-##[16 : personality & 0xff];
pin out bit and if personality & 0x100;
pin out bit or if personality & 0x200;
pin out bit xor if personality & 0x400;
function _ nofp;
description ""
Experimental general 'logic function' component. Can perform 'and', 'or'
and 'xor' of up to 16 inputs. Determine the proper value for 'personality'
by adding:
.IP \\(bu 4
The number of input pins, usually from 2 to 16
.IP \\(bu
256 (0x100) if the 'and' output is desired
.IP \\(bu
512 (0x200) if the 'or' output is desired
.IP \\(bu
1024 (0x400) if the 'xor' (exclusive or) output is desired"";
license "GPL"; // indicates GPL v2 or later
;;
FUNCTION(_) {
    int i, a=1, o=0, x=0;
    for(i=0; i < (personality & 0xff); i++) {
        if(in(i)) { o = 1; x = !x; }
        else { a = 0; }
    }
    if(personality & 0x100) and = a;
    if(personality & 0x200) or = o;
    if(personality & 0x400) xor = x;
}
```

A typical load line for this component might be

```
loadrt logic count=3 personality=0x102,0x305,0x503
```

which creates the following pins:

- A 2-input AND gate: logic.0.and, logic.0.in-00, logic.0.in-01
- 5-input AND and OR gates: logic.1.and, logic.1.or, logic.1.in-00, logic.1.in-01, logic.1.in-02, logic.1.in-03, logic.1.in-04,
- 3-input AND and XOR gates: logic.2.and, logic.2.xor, logic.2.in-00, logic.2.in-01, logic.2.in-02

Chapter 15

Creating Userspace Python Components

15.1 Basic usage

A userspace component begins by creating its pins and parameters, then enters a loop which will periodically drive all the outputs from the inputs. The following component copies the value seen on its input pin (*passthrough.in*) to its output pin (*passthrough.out*) approximately once per second.

```
#!/usr/bin/python
import hal, time
h = hal.component("passthrough")
h.newpin("in", hal.HAL_FLOAT, hal.HAL_IN)
h.newpin("out", hal.HAL_FLOAT, hal.HAL_OUT)
h.ready()
try:
    while 1:
        time.sleep(1)
        h['out'] = h['in']
except KeyboardInterrupt:
    raise SystemExit
```

Copy the above listing into a file named "passthrough", make it executable (*chmod +x*), and place it on your *\$PATH*. Then try it out:

```
halrun

halcmd: loadusr passthrough

halcmd: show pin

Component Pins:
Owner Type Dir      Value Name
 03  float IN        0    passthrough.in
 03  float OUT        0    passthrough.out

halcmd: setp passthrough.in 3.14

halcmd: show pin

Component Pins:
Owner Type Dir      Value Name
 03  float IN        3.14 passthrough.in
 03  float OUT        3.14 passthrough.out
```

15.2 Userspace components and delays

If you typed “show pin” quickly, you may see that *passthrough.out* still had its old value of 0. This is because of the call to *time.sleep(1)*, which makes the assignment to the output pin occur at most once per second. Because this is a userspace component, the actual delay between assignments can be much longer if the memory used by the passthrough component is swapped to disk, the assignment could be delayed until that memory is swapped back in.

Thus, userspace components are suitable for user-interactive elements such as control panels (delays in the range of milliseconds are not noticed, and longer delays are acceptable), but not for sending step pulses to a stepper driver board (delays must always be in the range of microseconds, no matter what).

15.3 Create pins and parameters

```
h = hal.component("passthrough")
```

The component itself is created by a call to the constructor *hal.component*. The arguments are the HAL component name and (optionally) the prefix used for pin and parameter names. If the prefix is not specified, the component name is used.

```
h.newpin("in", hal.HAL_FLOAT, hal.HAL_IN)
```

Then pins are created by calls to methods on the component object. The arguments are: pin name suffix, pin type, and pin direction. For parameters, the arguments are: parameter name suffix, parameter type, and parameter direction.

Table 15.1: HAL Option Names

Pin and Parameter Types:	HAL_BIT	HAL_FLOAT	HAL_S32	HAL_U32
Pin Directions:	HAL_IN	HAL_OUT	HAL_IO	
Parameter Directions:	HAL_RO	HAL_RW		

The full pin or parameter name is formed by joining the prefix and the suffix with a ".", so in the example the pin created is called *passthrough.in*.

```
h.ready()
```

Once all the pins and parameters have been created, call the *.ready()* method.

15.3.1 Changing the prefix

The prefix can be changed by calling the *.setprefix()* method. The current prefix can be retrieved by calling the *.getprefix()* method.

15.4 Reading and writing pins and parameters

For pins and parameters which are also proper Python identifiers, the value may be accessed or set using the attribute syntax:

```
h.out = h.in
```

For all pins, whether or not they are also proper Python identifiers, the value may be accessed or set using the subscript syntax:

```
h['out'] = h['in']
```

15.4.1 Driving output (HAL_OUT) pins

Periodically, usually in response to a timer, all HAL_OUT pins should be "driven" by assigning them a new value. This should be done whether or not the value is different than the last one assigned. When a pin is connected to a signal, its old output value is not copied into the signal, so the proper value will only appear on the signal once the component assigns a new value.

15.4.2 Driving bidirectional (HAL_IO) pins

The above rule does not apply to bidirectional pins. Instead, a bidirectional pin should only be driven by the component when the component wishes to change the value. For instance, in the canonical encoder interface, the encoder component only sets the *index-enable* pin to **FALSE** (when an index pulse is seen and the old value is **TRUE**), but never sets it to **TRUE**. Repeatedly driving the pin **FALSE** might cause the other connected component to act as though another index pulse had been seen.

15.5 Exiting

A *halcmd unload* request for the component is delivered as a *KeyboardInterrupt* exception. When an unload request arrives, the process should either exit in a short time, or call the *.exit()* method on the component if substantial work (such as reading or writing files) must be done to complete the shutdown process.

15.6 Project ideas

- Create an external control panel with buttons, switches, and indicators. Connect everything to a microcontroller, and connect the microcontroller to the PC using a serial interface. Python has a very capable serial interface module called [pyserial](#) (Ubuntu package name "python-serial", in the universe repository)
- Attach a [LCDProc](#)-compatible LCD module and use it to display a digital readout with information of your choice (Ubuntu package name "lcdproc", in the universe repository)
- Create a virtual control panel using any GUI library supported by Python (gtk, qt, wxwindows, etc)

Part II

Hardware Drivers

Chapter 16

AX5214H Driver

The Axiom Measurement & Control AX5214H is a 48 channel digital I/O board. It plugs into an ISA bus, and resembles a pair of 8255 chips. In fact it may be a pair of 8255 chips, but I'm not sure. If/when someone starts a driver for an 8255 they should look at the ax5214 code, much of the work is already done.

16.1 Installing

```
loadrt hal_ax5214h cfg="<config-string>"
```

The config string consists of a hex port address, followed by an 8 character string of "I" and "O" which sets groups of pins as inputs and outputs. The first two character set the direction of the first two 8 bit blocks of pins (0-7 and 8-15). The next two set blocks of 4 pins (16-19 and 20-23). The pattern then repeats, two more blocks of 8 bits (24-31 and 32-39) and two blocks of 4 bits (40-43 and 44-47). If more than one board is installed, the data for the second board follows the first. As an example, the string "0x220 IHIOHOO 0x300 OIOOIOIO" installs drivers for two boards. The first board is at address 0x220, and has 36 inputs (0-19 and 24-39) and 12 outputs (20-23 and 40-47). The second board is at address 0x300, and has 20 inputs (8-15, 24-31, and 40-43) and 28 outputs (0-7, 16-23, 32-39, and 44-47). Up to 8 boards may be used in one system.

16.2 Pins

- (bit) *ax5214.<boardnum>.out-<pinnum>* — Drives a physical output pin.
- (bit) *ax5214.<boardnum>.in-<pinnum>* — Tracks a physical input pin.
- (bit) *ax5214.<boardnum>.in-<pinnum>-not* — Tracks a physical input pin, inverted.

For each pin, <boardnum> is the board number (starts at zero), and <pinnum> is the I/O channel number (0 to 47).

Note that the driver assumes active LOW signals. This is so that modules such as OPTO-22 will work correctly (TRUE means output ON, or input energized). If the signals are being used directly without buffering or isolation the inversion needs to be accounted for. The in- HAL pin is TRUE if the physical pin is low (OPTO-22 module energized), and FALSE if the physical pin is high (OPTO-22 module off). The in-<pinnum>-not HAL pin is inverted — it is FALSE if the physical pin is low (OPTO-22 module energized). By connecting a signal to one or the other, the user can determine the state of the input.

16.3 Parameters

- (bit) *ax5214.<boardnum>.out-<pinnum>-invert* — Inverts an output pin.

The `-invert` parameter determines whether an output pin is active high or active low. If `-invert` is `FALSE`, setting the HAL out-pin `TRUE` drives the physical pin low, turning ON an attached OPTO-22 module, and `FALSE` drives it high, turning OFF the OPTO-22 module. If `-invert` is `TRUE`, then setting the HAL out-pin `TRUE` will drive the physical pin high and turn the module OFF.

16.4 Functions

- (funct) `ax5214.<boardnum>.read` — Reads all digital inputs on one board.
- (funct) `ax5214.<boardnum>.write` — Writes all digital outputs on one board.

Chapter 17

GS2 VFD Driver

This is a userspace HAL program for the GS2 series of VFD's at Automation Direct.

This component is loaded using the halcmd "loadusr" command:

```
loadusr -Wn spindle-vfd gs2_vfd -n spindle-vfd
```

The above command says: loadusr, wait for named to load, component gs2_vfd, named spindle-vfd

17.1 Command Line Options

- *-b or --bits <n>* (default 8) Set number of data bits to <n>, where n must be from 5 to 8 inclusive
- *-d or --device <path>* (default /dev/ttyS0) Set the name of the serial device node to use
- *-g or --debug* Turn on debugging messages. This will also set the verbose flag. Debug mode will cause all modbus messages to be printed in hex on the terminal.
- *-n or --name <string>* (default gs2_vfd) Set the name of the HAL module. The HAL comp name will be set to <string>, and all pin and parameter names will begin with <string>.
- *-p or --parity {even,odd,none}* (default odd) Set serial parity to even, odd, or none.
- *-r or --rate <n>* (default 38400) Set baud rate to <n>. It is an error if the rate is not one of the following: 110, 300, 600, 1200, 2400, 4800, 9600, 19200, 38400, 57600, 115200
- *-s or --stopbits {1,2}* (default 1) Set serial stop bits to 1 or 2
- *-t or --target <n>* (default 1) Set MODBUS target (slave) number. This must match the device number you set on the GS2.
- *-v or --verbose* Turn on debug messages.

Note

That if there are serial configuration errors, turning on verbose may result in a flood of timeout errors.

17.2 Pins

Where <n> is gs2_vfd or the name given during loading with the -n option.

- *<n>.DC-bus-volts* (float, out) The DC bus voltage of the VFD
-

- `<n>.at-speed` (bit, out) when drive is at commanded speed
- `<n>.err-reset` (bit, in) reset errors sent to VFD
- `<n>.firmware-revision` (s32, out) from the VFD
- `<n>.frequency-command` (float, out) from the VFD
- `<n>.frequency-out` (float, out) from the VFD
- `<n>.is-stopped` (bit, out) when the VFD reports 0 Hz output
- `<n>.load-percentage` (float, out) from the VFD
- `<n>.motor-RPM` (float, out) from the VFD
- `<n>.output-current` (float, out) from the VFD
- `<n>.output-voltage` (float, out) from the VFD
- `<n>.power-factor` (float, out) from the VFD
- `<n>.scale-frequency` (float, out) from the VFD
- `<n>.speed-command` (float, in) speed sent to VFD in RPM It is an error to send a speed faster than the Motor Max RPM as set in the VFD
- `<n>.spindle-fwd` (bit, in) 1 for FWD and 0 for REV sent to VFD
- `<n>.spindle-rev` (bit, in) 1 for REV and 0 if off
- `<n>.spindle-on` (bit, in) 1 for ON and 0 for OFF sent to VFD
- `<n>.status-1` (s32, out) Drive Status of the VFD (see the GS2 manual)
- `<n>.status-2` (s32, out) Drive Status of the VFD (see the GS2 manual)

Note

The status value is a sum of all the bits that are on. So a 163 which means the drive is in the run mode is the sum of 3 (run) + 32 (freq set by serial) + 128 (operation set by serial).

17.3 Parameters

Where `<n>` is `gs2_vfd` or the name given during loading with the `-n` option.

- `<n>.error-count` (s32, RW)
- `<n>.loop-time` (float, RW) how often the modbus is polled (default 0.1)
- `<n>.nameplate-HZ` (float, RW) Nameplate Hz of motor (default 60)
- `<n>.nameplate-RPM` (float, RW) Nameplate RPM of motor (default 1730)
- `<n>.retval` (s32, RW) the return value of an error in HAL
- `<n>.tolerance` (s32, RW) speed tolerance (default 0.01)

For an example of using this component to drive a spindle see the [GS2 Spindle](#) example.

Chapter 18

Mesa HostMot2 Driver

18.1 Introduction

HostMot2 is an FPGA configuration developed by Mesa Electronics for their line of *Anything I/O* motion control cards. The firmware is open source, portable and flexible. It can be configured (at compile-time) with zero or more instances (an object created at runtime) of each of several Modules: encoders (quadrature counters), PWM generators, and step/dir generators. The firmware can be configured (at run-time) to connect each of these instances to pins on the I/O headers. I/O pins not driven by a Module instance revert to general-purpose bi-directional digital I/O.

18.2 Firmware Binaries

50 Pin Header FPGA cards Several pre-compiled HostMot2 firmware binaries are available for the different Anything I/O boards. (This list is incomplete, check the hostmot2-firmware distribution for up-to-date firmware lists.)

- 3x20 (144 I/O pins): using hm2_pci module
 - 24-channel servo
 - 16-channel servo plus 24 step/dir generators
- 5i22 (96 I/O pins): using hm2_pci module
 - 16-channel servo
 - 8-channel servo plus 24 step/dir generators
- 5i20, 5i23, 4i65, 4i68 (72 I/O pins): using hm2_pci module
 - 12-channel servo
 - 8-channel servo plus 4 step/dir generators
 - 4-channel servo plus 8 step/dir generators
- 7i43 (48 I/O pins): using hm2_7i43 module
 - 8-channel servo (8 PWM generators & 8 encoders)
 - 4-channel servo plus 4 step/dir generators

DB25 FPGA cards The 5i25 Superport FPGA card is preprogrammed when purchased and does not need a firmware binary.

18.3 Installing Firmware

Depending on how you installed LinuxCNC you may have to open the Synaptic Package Manager from the System menu and install the package for your Mesa card. The quickest way to find them is to do a search for *hostmot2* in the Synaptic Package Manager. Mark the firmware for installation, then apply.

18.4 Loading HostMot2

The LinuxCNC support for the HostMot2 firmware is split into a generic driver called *hostmot2* and two low-level I/O drivers for the Anything I/O boards. The low-level I/O drivers are *hm2_7i43* and *hm2_pci* (for all the PCI- and PC-104/Plus-based Anything I/O boards). The *hostmot2* driver must be loaded first, using a HAL command like this:

```
loadrt hostmot2
```

See the *hostmot2(9)* man page for details.

The *hostmot2* driver by itself does nothing, it needs access to actual boards running the HostMot2 firmware. The low-level I/O drivers provide this access. The low-level I/O drivers are loaded with commands like this:

```
loadrt hm2_pci config="firmware=hm2/5i20/SVST8_4.BIT
num_encoders=3 num_pwmgens=3 num_stepgens=1"
```

The config parameters are described in the *hostmot2* man page.

18.5 Watchdog

The HostMot2 firmware may include a watchdog Module; if it does, the *hostmot2* driver will use it.

The watchdog must be petted by LinuxCNC periodically or it will bite.

When the watchdog bites, all the board's I/O pins are disconnected from their Module instances and become high-impedance inputs (pulled high), and all communication with the board stops. The state of the HostMot2 firmware modules is not disturbed (except for the configuration of the I/O Pins). Encoder instances keep counting quadrature pulses, and pwm- and step-generators keep generating signals (which are not relayed to the motors, because the I/O Pins have become inputs).

Resetting the watchdog resumes communication and resets the I/O pins to the configuration chosen at load-time.

If the firmware includes a watchdog, the following HAL objects will be exported:

18.5.1 Pins:

- *has_bit* - (bit i/o) True if the watchdog has bit, False if the watchdog has not bit. If the watchdog has bit and the *has_bit* bit is True, the user can reset it to False to resume operation.

18.5.2 Parameters:

- *timeout_ns* - (u32 read/write) Watchdog timeout, in nanoseconds. This is initialized to 1,000,000,000 (1 second) at module load time. If more than this amount of time passes between calls to the *pet_watchdog()* function, the watchdog will bite.

18.5.3 Functions:

- *pet_watchdog()* - Calling this function resets the watchdog timer and postpones the watchdog biting until *timeout_ns* nanoseconds later. This function should be added to the servo thread.

18.6 HostMot2 Functions

- `hm2_<BoardType>.<BoardNum>.read` - Read all inputs, update input HAL pins.
- `hm2_<BoardType>.<BoardNum>.write` - Write all outputs.
- `hm2_<BoardType>.<BoardNum>.pet-watchdog` - Pet the watchdog to keep it from biting us for a while.
- `hm2_<BoardType>.<BoardNum>.read_gpio` - Read the GPIO input pins only. (This function is not available on the 7i43 due to limitations of the EPP bus.)
- `hm2_<BoardType>.<BoardNum>.write_gpio` - Write the GPIO control registers and output pins only. (This function is not available on the 7i43 due to limitations of the EPP bus.)

Note

The above `read_gpio` and `write_gpio` functions should not normally be needed, since the GPIO bits are read and written along with everything else in the standard `read` and `write` functions above, which are normally run in the servo thread.

The `read_gpio` and `write_gpio` functions were provided in case some very fast (frequently updated) I/O is needed. These functions should be run in the base thread. If you have need for this, please send an email and tell us about it, and what your application is.

18.7 Pinouts

The hostmot2 driver does not have a particular pinout. The pinout comes from the firmware that the hostmot2 driver sends to the Anything I/O board. Each firmware has different pinout, and the pinout depends on how many of the available encoders, pwmgens, and stepgens are used. To get a pinout list for your configuration after loading LinuxCNC in the terminal window type:

```
dmesg > hm2.txt
```

The resulting text file will contain lots of information as well as the pinout for the HostMot2 and any error and warning messages.

To reduce the clutter by clearing the message buffer before loading LinuxCNC type the following in the terminal window:

```
sudo dmesg -c
```

Now when you run LinuxCNC and then do a `dmesg > hm2.txt` in the terminal only the info from the time you loaded LinuxCNC will be in your file along with your pinout. The file will be in the current directory of the terminal window. Each line will contain the card name, the card number, the I/O Pin number, the connector and pin, and the usage. From this printout you will know the physical connections to your card based on your configuration.

An example of a 5i20 configuration:

```
[HOSTMOT2]
DRIVER=hm2_pci
BOARD=5i20
CONFIG="firmware=hm2/5i20/SVST8_4.BIT num_encoders=1 num_pwmgens=1 num_stepgens=3"
```

The above configuration produced this printout.

```
[ 1141.053386] hm2/hm2_5i20.0: 72 I/O Pins used:
[ 1141.053394] hm2/hm2_5i20.0: IO Pin 000 (P2-01): IOPort
[ 1141.053397] hm2/hm2_5i20.0: IO Pin 001 (P2-03): IOPort
[ 1141.053401] hm2/hm2_5i20.0: IO Pin 002 (P2-05): Encoder #0, pin B (Input)
[ 1141.053405] hm2/hm2_5i20.0: IO Pin 003 (P2-07): Encoder #0, pin A (Input)
[ 1141.053408] hm2/hm2_5i20.0: IO Pin 004 (P2-09): IOPort
[ 1141.053411] hm2/hm2_5i20.0: IO Pin 005 (P2-11): Encoder #0, pin Index (Input)
[ 1141.053415] hm2/hm2_5i20.0: IO Pin 006 (P2-13): IOPort
```

```
[ 1141.053418] hm2/hm2_5i20.0: IO Pin 007 (P2-15): PWMGen #0, pin Out0 (PWM or Up) (Output)
[ 1141.053422] hm2/hm2_5i20.0: IO Pin 008 (P2-17): IOPort
[ 1141.053425] hm2/hm2_5i20.0: IO Pin 009 (P2-19): PWMGen #0, pin Out1 (Dir or Down) ( ←
Output)
[ 1141.053429] hm2/hm2_5i20.0: IO Pin 010 (P2-21): IOPort
[ 1141.053432] hm2/hm2_5i20.0: IO Pin 011 (P2-23): PWMGen #0, pin Not-Enable (Output)
<snip>...
[ 1141.053589] hm2/hm2_5i20.0: IO Pin 060 (P4-25): StepGen #2, pin Step (Output)
[ 1141.053593] hm2/hm2_5i20.0: IO Pin 061 (P4-27): StepGen #2, pin Direction (Output)
[ 1141.053597] hm2/hm2_5i20.0: IO Pin 062 (P4-29): StepGen #2, pin (unused) (Output)
[ 1141.053601] hm2/hm2_5i20.0: IO Pin 063 (P4-31): StepGen #2, pin (unused) (Output)
[ 1141.053605] hm2/hm2_5i20.0: IO Pin 064 (P4-33): StepGen #2, pin (unused) (Output)
[ 1141.053609] hm2/hm2_5i20.0: IO Pin 065 (P4-35): StepGen #2, pin (unused) (Output)
[ 1141.053613] hm2/hm2_5i20.0: IO Pin 066 (P4-37): IOPort
[ 1141.053616] hm2/hm2_5i20.0: IO Pin 067 (P4-39): IOPort
[ 1141.053619] hm2/hm2_5i20.0: IO Pin 068 (P4-41): IOPort
[ 1141.053621] hm2/hm2_5i20.0: IO Pin 069 (P4-43): IOPort
[ 1141.053624] hm2/hm2_5i20.0: IO Pin 070 (P4-45): IOPort
[ 1141.053627] hm2/hm2_5i20.0: IO Pin 071 (P4-47): IOPort
[ 1141.053811] hm2/hm2_5i20.0: registered
[ 1141.053815] hm2_5i20.0: initialized AnyIO board at 0000:02:02.0
```

Note

That the I/O Pin nnn will correspond to the pin number shown on the HAL Configuration screen for GPIOs. Some of the Stepper, Encoder and PWMGen will also show up as GPIOs in the HAL Configuration screen.

18.8 PIN Files

The default pinout is described in a .PIN file (human-readable text). When you install a firmware package the .PIN files are installed in

```
/usr/share/doc/hostmot2-firmware-<board>/
```

18.9 Firmware

The selected firmware (.BIT file) and configuration is uploaded from the PC motherboard to the Mesa mothercard on LinuxCNC startup. If you are using Run In Place, you must still install a hostmot2-firmware-<board> package. There is more information about firmware and configuration in the *Configurations* section.

18.10 HAL Pins

The HAL pins for each configuration can be seen by opening up *Show HAL Configuration* from the Machine menu. All the HAL pins and parameters can be found there. The following figure is of the 5i20 configuration used above.

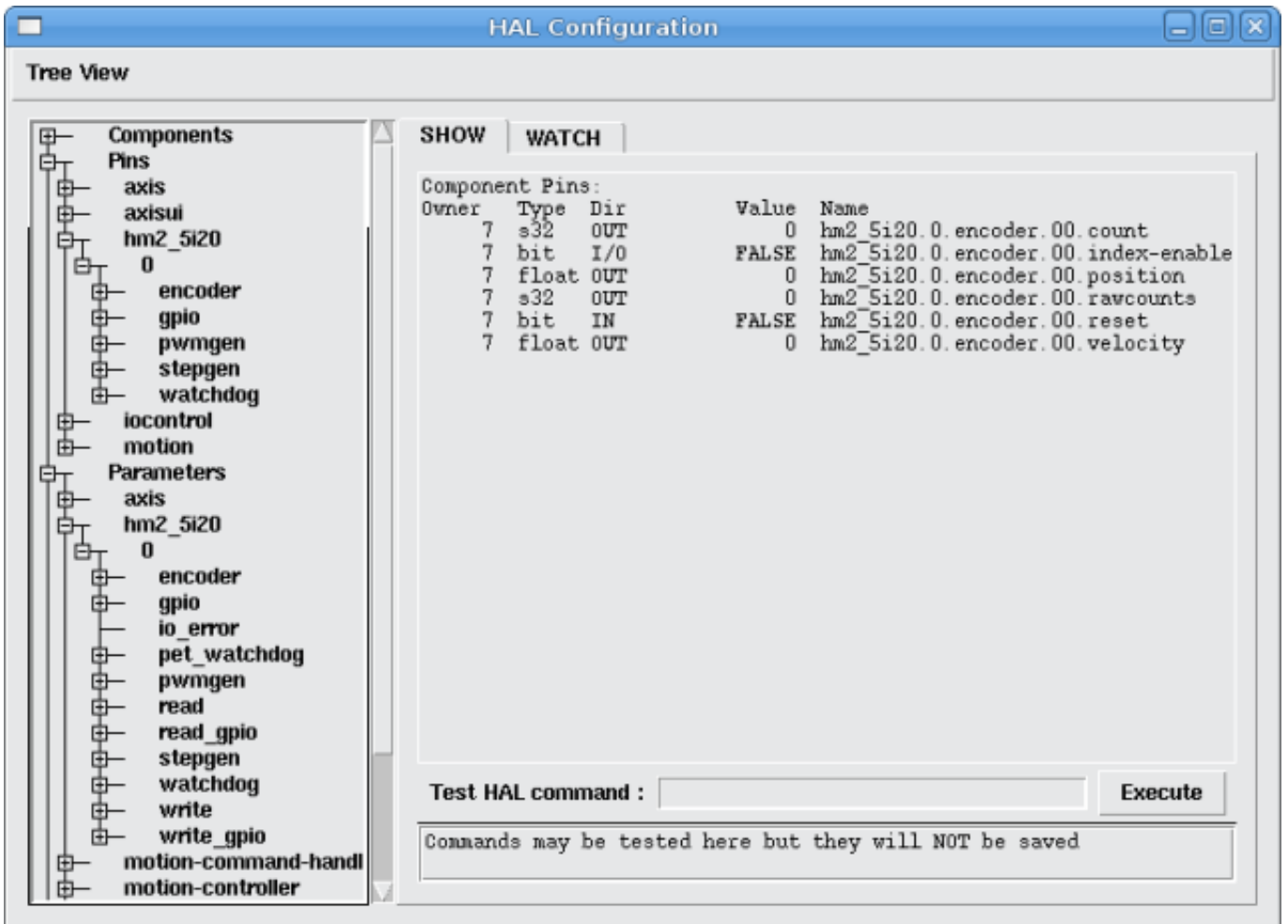

Figure 18.1: 5i20 HAL Pins

18.11 Configurations

The Hostmot2 firmware is available in several versions, depending on what you are trying to accomplish. You can get a reminder of what a particular firmware is for by looking at the name. Let's look at a couple of examples.

In the 7i43 (two ports), SV8 (*Servo 8*) would be for having 8 servos or fewer, using the *classic* 7i33 4-axis (per port) servo board. So 8 servos would use up all 48 signals in the two ports. But if you only needed 3 servos, you could say `num_encoders=3` and `num_pwmgens=3` and recover 5 servos at 6 signals each, thus gaining 30 bits of GPIO.

Or, in the 5i22 (four ports), SVST8_24 (*Servo 8, Stepper 24*) would be for having 8 servos or fewer (7i33 x2 again), and 24 steppers or fewer (7i47 x2). This would use up all four ports. If you only needed 4 servos you could say `num_encoders=4` and `num_pwmgens=4` and recover 1 port (and save a 7i33). And if you only needed 12 steppers you could say `num_stepgens=12` and free up one port (and save a 7i47). So in this way we can save two ports (48 bits) for GPIO.

Here are tables of the firmwares available in the official packages. There may be additional firmwares available at the Mesanet.com website that have not yet made it into the LinuxCNC official firmware packages, so check there too.

3x20 (6-port various) Default Configurations (The 3x20 comes in 1M, 1.5M, and 2M gate versions. So far, all firmware is available in all gate sizes.)

Firmware	Encoder	PWMGen	StepGen	GPIO
SV24	24	24	0	0
SVST16_24	16	16	24	0

5i22 (4-port PCI) Default Configurations (The 5i22 comes in 1M and 1.5M gate versions. So far, all firmware is available in all gate sizes.)

Firmware	Encoder	PWM	StepGen	GPIO
SV16	16	16	0	0
SVST2_4_7I47	4	2	4	72
SVST8_8	8	8	8	0
SVST8_24	8	8	24	0

5i23 (3-port PCI) Default Configurations (The 5i23 has 400k gates.)

Firmware	Encoder	PWM	StepGen	GPIO
SV12	12	12	0	0
SVST2_8	2	2	8 (tbl5)	12
SVST2_4_7I47	4	2	4	48
SV12_2X7I48_72	12	12	0	24
SV12IM_2X7I48_72	12 (+IM)	12	0	12
SVST4_8	4	4	8 (tbl5)	0
SVST8_4	8	8	4 (tbl5)	0
SVST8_4IM2	8 (+IM)	8	4	8
SVST8_8IM2	8 (+IM)	8	8	0
SVTP6_7I39	6	0 (6 BLDC)	0	0

5i20 (3-port PCI) Default Configurations (The 5i20 has 200k gates.)

Firmware	Encoder	PWM	StepGen	GPIO
SV12	12	12	0	0
SVST2_8	2	2	8 (tbl5)	12
SVST2_4_7I47	4	2	4	48
SV12_2X7I48_72	12	12	0	24
SV12IM_2X7I48_72	12 (+IM)	12	0	12
SVST8_4	8	8	4 (tbl5)	0
SVST8_4IM2	8 (+IM)	8	4	8

4i68 (3-port PC/104) Default Configurations (The 4i68 has 400k gates.)

Firmware	Encoder	PWM	StepGen	GPIO
SV12	12	12	0	0
SVST2_4_7I47	4	2	4	48
SVST4_8	4	4	8	0
SVST8_4	8	8	4	0
SVST8_4IM2	8 (+IM)	8	4	8
SVST8_8IM2	8 (+IM)	8	8	0

4i65 (3-port PC/104) Default Configurations (The 4i65 has 200k gates.)

Firmware	Encoder	PWM	StepGen	GPIO
SV12	12	12	0	0
SVST8_4	8	8	4	0
SVST8_4IM2	8 (+IM)	8	4	8

7i43 (2-port parallel) 400k gate versions, Default Configurations

Firmware	Encoder	PWM	StepGen	GPIO
SV8	8	8	0	0
SVST4_4	4	4	4 (tbl5)	0
SVST4_6	4	4	6 (tbl3)	0
SVST4_12	4	4	12	0
SVST2_4_7I47	4	2	4	24

7i43 (2-port parallel) 200k gate versions, Default Configurations

Firmware	Encoder	PWM	StepGen	GPIO
SV8	8	8	0	0
SVST4_4	4	4	4 (tbl5)	0
SVST4_6	4	4	6 (tbl3)	0
SVST2_4_7I47	4	2	4	24

Even though several cards may have the same named .BIT file you cannot use a .BIT file that is not for that card. Different cards have different clock frequencies so make sure you load the proper .BIT file for your card. Custom hm2 firmwares can be created for special applications and you may see some custom hm2 firmwares in the directories with the default ones.

When you load the board-driver (hm2_pci or hm2_7i43), you can tell it to disable instances of the three primary modules (pwmgen, stepgen, and encoder) by setting the count lower. Any I/O pins belonging to disabled module instances become GPIOs.

18.12 GPIO

General Purpose I/O pins on the board which are not used by a module instance are exported to HAL as *full* GPIO pins. Full GPIO pins can be configured at run-time to be inputs, outputs, or open drains, and have a HAL interface that exposes this flexibility. I/O pins that are owned by an active module instance are constrained by the requirements of the owning module, and have a restricted HAL interface.

GPIOs have names like *hm2_<BoardType>.<BoardNum>.gpio.<IONum>*. IONum. is a three-digit number. The mapping from IONum to connector and pin-on-that-connector is written to the syslog when the driver loads, and it's documented in Mesa's manual for the Anything I/O boards.

The hm2 GPIO representation is modeled after the Digital Inputs and Digital Outputs described in the Canonical Device Interface (part of the HAL General Reference document).

GPIO pins default to input.

18.12.1 Pins

- *in* - (Bit, Out) Normal state of the hardware input pin. Both full GPIO pins and I/O pins used as inputs by active module instances have this pin.
- *in_not* - (Bit, Out) Inverted state of the hardware input pin. Both full GPIO pins and I/O pins used as inputs by active module instances have this pin.
- *out* - (Bit, In) Value to be written (possibly inverted) to the hardware output pin. Only full GPIO pins have this pin.

18.12.2 Parameters

- *invert_output* - (Bit, RW) This parameter only has an effect if the *is_output* parameter is true. If this parameter is true, the output value of the GPIO will be the inverse of the value on the *out* HAL pin. Only full GPIO pins and I/O pins used as outputs by active module instances have this parameter. To invert an active module pin you have to invert the GPIO pin not the module pin.

- *is_opendrain* - (Bit, RW) This parameter only has an effect if the *is_output* parameter is true. If this parameter is false, the GPIO behaves as a normal output pin: the I/O pin on the connector is driven to the value specified by the *out* HAL pin (possibly inverted), and the value of the *in* and *in_not* HAL pins is undefined. If this parameter is true, the GPIO behaves as an open-drain pin. Writing 0 to the *out* HAL pin drives the I/O pin low, writing 1 to the *out* HAL pin puts the I/O pin in a high-impedance state. In this high-impedance state the I/O pin floats (weakly pulled high), and other devices can drive the value; the resulting value on the I/O pin is available on the *in* and *in_not* pins. Only full GPIO pins and I/O pins used as outputs by active module instances have this parameter.
- *is_output* - (Bit, RW) If set to 0, the GPIO is an input. The I/O pin is put in a high-impedance state (weakly pulled high), to be driven by other devices. The logic value on the I/O pin is available in the *in* and *in_not* HAL pins. Writes to the *out* HAL pin have no effect. If this parameter is set to 1, the GPIO is an output; its behavior then depends on the *is_opendrain* parameter. Only full GPIO pins have this parameter.

18.13 StepGen

Stepgens have names like *hm2_<BoardType>.<BoardNum>.stepgen.<Instance>..* *Instance* is a two-digit number that corresponds to the HostMot2 stepgen instance number. There are *num_stepgens* instances, starting with 00.

Each stepgen allocates 2-6 I/O pins (selected at firmware compile time), but currently only uses two: Step and Direction outputs.¹

The stepgen representation is modeled on the stepgen software component. Stepgen default is active high step output (high during step time low during step space). To invert a StepGen output pin you invert the corresponding GPIO pin that is being used by StepGen. To find the GPIO pin being used for the StepGen output run *dmesg* as shown above.

Each stepgen instance has the following pins and parameters:

18.13.1 Pins

- *control-type* - (Bit, In) Switches between position control mode (0) and velocity control mode (1). Defaults to position control (0).
- *counts* - (s32, Out) Feedback position in counts (number of steps).
- *enable* - (Bit, In) Enables output steps. When false, no steps are generated.
- *position-cmd* - (Float, In) Target position of stepper motion, in user-defined position units.
- *position-fb* - (Float, Out) Feedback position in user-defined position units (counts / position_scale).
- *velocity-cmd* - (Float, In) Target velocity of stepper motion, in user-defined position units per second. This pin is only used when the stepgen is in velocity control mode (*control-type*=1).
- *velocity-fb* - (Float, Out) Feedback velocity in user-defined position units per second.

18.13.2 Parameters

- *dirhold* - (u32, RW) Minimum duration of stable Direction signal after a step ends, in nanoseconds.
- *dirsetup* - (u32, RW) Minimum duration of stable Direction signal before a step begins, in nanoseconds.
- *maxaccel* - (Float, RW) Maximum acceleration, in position units per second per second. If set to 0, the driver will not limit its acceleration.
- *maxvel* - (Float, RW) Maximum speed, in position units per second. If set to 0, the driver will choose the maximum velocity based on the values of *steplen* and *stepspace* (at the time that *maxvel* was set to 0).
- *position-scale* - (Float, RW) Converts from counts to position units. $position = counts / position_scale$

¹ At present, the firmware supports multi-phase stepper outputs, but the driver doesn't. Interested volunteers are solicited.

- *step_type* - (u32, RW) Output format, like the *step_type* modparam to the software *stegen(9)* component. 0 = Step/Dir, 1 = Up/Down, 2 = Quadrature. In Quadrature mode (*step_type*=2), the *stepgen* outputs one complete Gray cycle (00 -> 01 -> 11 -> 10 -> 00) for each *step* it takes.
- *steplen* - (u32, RW) Duration of the step signal, in nanoseconds.
- *stepspace* - (u32, RW) Minimum interval between step signals, in nanoseconds.

18.13.3 Output Parameters

The Step and Direction pins of each StepGen have two additional parameters. To find which I/O pin belongs to which step and direction output run *dmesg* as described above.

- *invert_output* - (Bit, RW) This parameter only has an effect if the *is_output* parameter is true. If this parameter is true, the output value of the GPIO will be the inverse of the value on the *out* HAL pin.
- *is_opendrain* - (Bit, RW) If this parameter is false, the GPIO behaves as a normal output pin: the I/O pin on the connector is driven to the value specified by the *out* HAL pin (possibly inverted). If this parameter is true, the GPIO behaves as an open-drain pin. Writing 0 to the *out* HAL pin drives the I/O pin low, writing 1 to the *out* HAL pin puts the I/O pin in a high-impedance state. In this high-impedance state the I/O pin floats (weakly pulled high), and other devices can drive the value; the resulting value on the I/O pin is available on the *in* and *in_not* pins. Only full GPIO pins and I/O pins used as outputs by active module instances have this parameter.

18.14 PWMGen

PWMgens have names like *hm2_<BoardType>.<BoardNum>.pwmgen.<Instance>*. *Instance* is a two-digit number that corresponds to the HostMot2 *pwmgen* instance number. There are *num_pwmgens* instances, starting with 00.

In HM2, each *pwmgen* uses three output I/O pins: Not-Enable, Out0, and Out1. To invert a PWMGen output pin you invert the corresponding GPIO pin that is being used by PWMGen. To find the GPIO pin being used for the PWMGen output run *dmesg* as shown above.

The function of the Out0 and Out1 I/O pins varies with output-type parameter (see below).

The *hm2* *pwmgen* representation is similar to the software *pwmgen* component. Each *pwmgen* instance has the following pins and parameters:

18.14.1 Pins

- *enable* - (Bit, In) If true, the *pwmgen* will set its Not-Enable pin false and output its pulses. If *enable* is false, *pwmgen* will set its Not-Enable pin true and not output any signals.
- *value* - (Float, In) The current *pwmgen* command value, in arbitrary units.

18.14.2 Parameters

- *output-type* - (s32, RW) This emulates the *output_type* load-time argument to the software *pwmgen* component. This parameter may be changed at runtime, but most of the time you probably want to set it at startup and then leave it alone. Accepted values are 1 (PWM on Out0 and Direction on Out1), 2 (Up on Out0 and Down on Out1), 3 (PDM mode, PDM on Out0 and Dir on Out1), and 4 (Direction on Out0 and PWM on Out1, *for locked antiphase*).
- *scale* - (Float, RW) Scaling factor to convert *value* from arbitrary units to duty cycle: $dc = value / scale$. Duty cycle has an effective range of -1.0 to +1.0 inclusive, anything outside that range gets clipped.

- *pdm_frequency* - (u32, RW) This specifies the PDM frequency, in Hz, of all the pwmgen instances running in PDM mode (mode 3). This is the *pulse slot frequency*; the frequency at which the pdm generator in the Anything I/O board chooses whether to emit a pulse or a space. Each pulse (and space) in the PDM pulse train has a duration of $1/\text{pdm_frequency}$ seconds. For example, setting the *pdm_frequency* to 2e6 (2 MHz) and the duty cycle to 50% results in a 1 MHz square wave, identical to a 1 MHz PWM signal with 50% duty cycle. The effective range of this parameter is from about 1525 Hz up to just under 100 MHz. Note that the max frequency is determined by the ClockHigh frequency of the Anything I/O board; the 5i20 and 7i43 both have a 100 MHz clock, resulting in a 100 Mhz max PDM frequency. Other boards may have different clocks, resulting in different max PDM frequencies. If the user attempts to set the frequency too high, it will be clipped to the max supported frequency of the board.
- *pwm_frequency* - (u32, RW) This specifies the PWM frequency, in Hz, of all the pwmgen instances running in the PWM modes (modes 1 and 2). This is the frequency of the variable-duty-cycle wave. Its effective range is from 1 Hz up to 193 KHz. Note that the max frequency is determined by the ClockHigh frequency of the Anything I/O board; the 5i20 and 7i43 both have a 100 MHz clock, resulting in a 193 KHz max PWM frequency. Other boards may have different clocks, resulting in different max PWM frequencies. If the user attempts to set the frequency too high, it will be clipped to the max supported frequency of the board. Frequencies below about 5 Hz are not terribly accurate, but above 5 Hz they're pretty close.

18.14.3 Output Parameters

The output pins of each PWMGen have two additional parameters. To find which I/O pin belongs to which output run `dmesg` as described above.

- *invert_output* - (Bit, RW) This parameter only has an effect if the *is_output* parameter is true. If this parameter is true, the output value of the GPIO will be the inverse of the value on the *out* HAL pin.
- *is_opendrain* - (Bit, RW) If this parameter is false, the GPIO behaves as a normal output pin: the I/O pin on the connector is driven to the value specified by the *out* HAL pin (possibly inverted). If this parameter is true, the GPIO behaves as an open-drain pin. Writing 0 to the *out* HAL pin drives the I/O pin low, writing 1 to the *out* HAL pin puts the I/O pin in a high-impedance state. In this high-impedance state the I/O pin floats (weakly pulled high), and other devices can drive the value; the resulting value on the I/O pin is available on the *in* and *in_not* pins. Only full GPIO pins and I/O pins used as outputs by active module instances have this parameter.

18.15 Encoder

Encoders have names like `hm2_<BoardType>.<BoardNum>.encoder.<Instance>..` *Instance* is a two-digit number that corresponds to the HostMot2 encoder instance number. There are *num_encoders* instances, starting with 00.

Each encoder uses three or four input I/O pins, depending on how the firmware was compiled. Three-pin encoders use A, B, and Index (sometimes also known as Z). Four-pin encoders use A, B, Index, and Index-mask.

The hm2 encoder representation is similar to the one described by the Canonical Device Interface (in the HAL General Reference document), and to the software encoder component. Each encoder instance has the following pins and parameters:

18.15.1 Pins

- *count* - (s32, Out) Number of encoder counts since the previous reset.
- *index-enable* - (Bit, I/O) When this pin is set to True, the count (and therefore also position) are reset to zero on the next Index (Phase-Z) pulse. At the same time, *index-enable* is reset to zero to indicate that the pulse has occurred.
- *position* - (Float, Out) Encoder position in position units (count / scale).
- *rawcounts* - (s32, Out) Total number of encoder counts since the start, not adjusted for index or reset.
- *reset* - (Bit, In) When this pin is TRUE, the count and position pins are set to 0. (The value of the velocity pin is not affected by this.) The driver does not reset this pin to FALSE after resetting the count to 0, that is the user's job.
- *velocity* - (Float, Out) Estimated encoder velocity in position units per second.

18.15.2 Parameters

- *counter-mode* - (Bit, RW) Set to False (the default) for Quadrature. Set to True for Up/Down or for single input on Phase A. Can be used for a frequency to velocity converter with a single input on Phase A when set to true.
- *filter* - (Bit, RW) If set to True (the default), the quadrature counter needs 15 clocks to register a change on any of the three input lines (any pulse shorter than this is rejected as noise). If set to False, the quadrature counter needs only 3 clocks to register a change. The encoder sample clock runs at 33 MHz on the PCI Anything I/O cards and 50 MHz on the 7i43.
- *index-invert* - (Bit, RW) If set to True, the rising edge of the Index input pin triggers the Index event (if index-enable is True). If set to False, the falling edge triggers.
- *index-mask* - (Bit, RW) If set to True, the Index input pin only has an effect if the Index-Mask input pin is True (or False, depending on the index-mask-invert pin below).
- *index-mask-invert* - (Bit, RW) If set to True, Index-Mask must be False for Index to have an effect. If set to False, the Index-Mask pin must be True.
- *scale* - (Float, RW) Converts from *count* units to *position* units. A quadrature encoder will normally have 4 counts per pulse so a 100 PPR encoder would be 400 counts per revolution. In *.counter-mode* a 100 PPR encoder would have 100 counts per revolution as it only uses the rising edge of A and direction is B.
- *vel-timeout* - (Float, RW) When the encoder is moving slower than one pulse for each time that the driver reads the count from the FPGA (in the `hm2_read()` function), the velocity is harder to estimate. The driver can wait several iterations for the next pulse to arrive, all the while reporting the upper bound of the encoder velocity, which can be accurately guessed. This parameter specifies how long to wait for the next pulse, before reporting the encoder stopped. This parameter is in seconds.

18.16 5i25 Configuration

18.16.1 Firmware

The 5i25 firmware comes preloaded for the daughter card it is purchased with. So the *firmware=xxx.BIT* is not part of the `hm2_pci` configuration string when using a 5i25.

18.16.2 Configuration

Example configurations of the 5i25/7i76 and 5i25/7i77 cards are included in the [Configuration Selector](#).

If you like to roll your own configuration the following examples show how to load the drivers in the HAL file.

5i25 + 7i76 Card

```
# load the generic driver
loadrt hostmot2

# load the PCI driver and configure
loadrt hm2_pci config="num_encoders=1 num_stepgens=5 sserial_port_0=0XXX"
```

5i25 + 7i77 Card

```
# load the generic driver
loadrt hostmot2

# load the PCI driver and configure
loadrt hm2_pci config="num_encoders=6 num_pwmgens=6 sserial_port_0=0XXX"
```

18.16.3 SSERIAL Configuration

The `sserial_port_0=0XXX` configuration string sets some options for the smart serial daughter card. These options are specific for each daughter card. See the Mesa manual for more information on the exact usage.

18.16.4 7i77 Limits

The `minlimit` and `maxlimit` are bounds on the pin value (in this case the analog out value) `fullscalemax` is the scale factor.

These are by default set to the analog in or analog range (most likely in volts).

So for example on the 7I77 +-10V analog outputs, the default values are:

```
minlimit -10 maxlimit +10 maxfullscale 10
```

If you wanted to say scale the analog out of a channel to IPS for a velocity mode servo (say 24 IPS max) you could set the limits like this:

```
minlimit -24 maxlimit +24 maxfullscale 24
```

If you wanted to scale the analog out of a channel to RPM for a 0 to 6000 RPM spindle with 0-10V control you could set the limits like this:

```
minlimit 0 maxlimit 6000 maxfullscale 6000 (this would prevent unwanted negative output voltages from being set)
```

18.17 Example Configurations

Several example configurations for Mesa hardware are included with LinuxCNC. The configurations are located in the `hm2-servo` and `hm2-stepper` sections of the [Configuration Selector](#). Typically you will need the board installed for the configuration you pick to load. The examples are a good place to start and will save you time. Just pick the proper example from the LinuxCNC Configuration Selector and save a copy to your computer so you can edit it. To see the exact pins and parameters that your configuration gave you, open the Show HAL Configuration window from the Machine menu, or do `dmesg` as outlined above.

Chapter 19

Motenc Driver

Vital Systems Motenc-100 and Motenc-LITE

The Vital Systems Motenc-100 and Motenc-LITE are 8- and 4-channel servo control boards. The Motenc-100 provides 8 quadrature encoder counters, 8 analog inputs, 8 analog outputs, 64 (68?) digital inputs, and 32 digital outputs. The Motenc-LITE has only 4 encoder counters, 32 digital inputs and 16 digital outputs, but it still has 8 analog inputs and 8 analog outputs. The driver automatically identifies the installed board and exports the appropriate HAL objects.

Installing:

```
loadrt hal_motenc
```

During loading (or attempted loading) the driver prints some useful debugging messages to the kernel log, which can be viewed with `dmesg`.

Up to 4 boards may be used in one system.

19.1 Pins

In the following pins, parameters, and functions, `<board>` is the board ID. According to the naming conventions the first board should always have an ID of zero. However this driver sets the ID based on a pair of jumpers on the board, so it may be non-zero even if there is only one board.

- *(s32)* `motenc.<board>.enc-<channel>-count` - Encoder position, in counts.
- *(float)* `motenc.<board>.enc-<channel>-position` - Encoder position, in user units.
- *(bit)* `motenc.<board>.enc-<channel>-index` - Current status of index pulse input.
- *(bit)* `motenc.<board>.enc-<channel>-idx-latch` - Driver sets this pin true when it latches an index pulse (enabled by `latch-index`). Cleared by clearing `latch-index`.
- *(bit)* `motenc.<board>.enc-<channel>-latch-index` - If this pin is true, the driver will reset the counter on the next index pulse.
- *(bit)* `motenc.<board>.enc-<channel>-reset-count` - If this pin is true, the counter will immediately be reset to zero, and the pin will be cleared.
- *(float)* `motenc.<board>.dac-<channel>-value` - Analog output value for DAC (in user units, see `-gain` and `-offset`)
- *(float)* `motenc.<board>.adc-<channel>-value` - Analog input value read by ADC (in user units, see `-gain` and `-offset`)
- *(bit)* `motenc.<board>.in-<channel>` - State of digital input pin, see canonical digital input.
- *(bit)* `motenc.<board>.in-<channel>-not` - Inverted state of digital input pin, see canonical digital input.

- (bit) *motenc.<board>.out-<channel>* - Value to be written to digital output, seen canonical digital output.
- (bit) *motenc.<board>.estop-in* - Dedicated estop input, more details needed.
- (bit) *motenc.<board>.estop-in-not* - Inverted state of dedicated estop input.
- (bit) *motenc.<board>.watchdog-reset* - Bidirectional, - Set TRUE to reset watchdog once, is automatically cleared.

19.2 Parameters

- (float) *motenc.<board>.enc-<channel>-scale* - The number of counts / user unit (to convert from counts to units).
- (float) *motenc.<board>.dac-<channel>-offset* - Sets the DAC offset.
- (float) *motenc.<board>.dac-<channel>-gain* - Sets the DAC gain (scaling).
- (float) *motenc.<board>.adc-<channel>-offset* - Sets the ADC offset.
- (float) *motenc.<board>.adc-<channel>-gain* - Sets the ADC gain (scaling).
- (bit) *motenc.<board>.out-<channel>-invert* - Inverts a digital output, see canonical digital output.
- (u32) *motenc.<board>.watchdog-control* - Configures the watchdog. The value may be a bitwise OR of the following values:

Bit #	Value	Meaning
0	1	Timeout is 16ms if set, 8ms if unset
1	2	
2	4	Watchdog is enabled
3	8	
4	16	Watchdog is automatically reset by DAC writes (the HAL dac-write function)

Typically, the useful values are 0 (watchdog disabled) or 20 (8ms watchdog enabled, cleared by dac-write).

- (u32) *motenc.<board>.led-view* - Maps some of the I/O to onboard LEDs.

19.3 Functions

- (funct) *motenc.<board>.encoder-read* - Reads all encoder counters.
- (funct) *motenc.<board>.adc-read* - Reads the analog-to-digital converters.
- (funct) *motenc.<board>.digital-in-read* - Reads digital inputs.
- (funct) *motenc.<board>.dac-write* - Writes the voltages to the DACs.
- (funct) *motenc.<board>.digital-out-write* - Writes digital outputs.
- (funct) *motenc.<board>.misc-update* - Updates misc stuff.

Chapter 20

Opto22 Driver

PCI AC5 ADAPTER CARD / HAL DRIVER

20.1 The Adapter Card

This is a card made by Opto22 for adapting the PCI port to solid state relay racks such as their standard or G4 series. It has 2 ports that can control up to 24 points each and has 4 on board LEDs. The ports use 50 pin connectors the same as Mesa boards. Any relay racks/breakout boards that work with Mesa Cards should work with this card with the understanding any encoder counters, PWM, etc., would have to be done in software. The AC5 does not have any *smart* logic on board, it is just an adapter.

See the manufacturer's website for more info:

http://www.opto22.com/site/pr_details.aspx?cid=4&item=PCI-AC5

I would like to thank Opto22 for releasing info in their manual, easing the writing of this driver!

20.2 The Driver

This driver is for the PCI AC5 card and will not work with the ISA AC5 card. The HAL driver is a realtime module. It will support 4 cards as is (more cards are possible with a change in the source code). Load the basic driver like so:

```
loadrt opto_ac5
```

This will load the driver which will search for max 4 boards. It will set I/O of each board's 2 ports to a default setting. The default configuration is for 12 inputs then 12 outputs. The pin name numbers correspond to the position on the relay rack. For example the pin names for the default I/O setting of port 0 would be:

- *opto_ac5.0.port0.in-00* - They would be numbered from 00 to 11
- *opto_ac5.0.port0.out-12* - They would be numbered 12 to 23 port 1 would be the same.

20.3 Pins

- *opto_ac5.[BOARDNUMBER].port[PORTNUMBER].in-[PINNUMBER] OUT bit* -
- *opto_ac5.[BOARDNUMBER].port[PORTNUMBER].in-[PINNUMBER]-not OUT bit* - Connect a HAL bit signal to this pin to read an I/O point from the card. The PINNUMBER represents the position in the relay rack. Eg. PINNUMBER 0 is position 0 in a Opto22 relay rack and would be pin 47 on the 50 pin header connector. The -not pin is inverted so that LOW gives TRUE and HIGH gives FALSE.

- *opto_ac5.[BOARDNUMBER].port[PORTNUMBER].out-[PINNUMBER] IN bit* - Connect a HAL bit signal to this pin to write to an I/O point of the card. The PINNUMBER represents the position in the relay rack. Eg. PINNUMBER 23 is position 23 in a Opto22 relay rack and would be pin 1 on the 50 pin header connector.
- *opto_ac5.[BOARDNUMBER].led[NUMBER] OUT bit* - Turns one of the 4 onboard LEDs on/off. LEDs are numbered 0 to 3.

BOARDNUMBER can be 0-3 PORTNUMBER can be 0 or 1. Port 0 is closest to the card bracket.

20.4 Parameters

- *opto_ac5.[BOARDNUMBER].port[PORTNUMBER].out-[PINNUMBER]-invert W bit* - When TRUE, invert the meaning of the corresponding -out pin so that TRUE gives LOW and FALSE gives HIGH.

20.5 FUNCTIONS

- *opto_ac5.0.digital-read* - Add this to a thread to read all the input points.
- *opto_ac5.0.digital-write* - Add this to a thread to write all the output points and LEDs.

For example the pin names for the default I/O setting of port 0 would be:

```
opto_ac5.0.port0.in-00
```

They would be numbered from 00 to 11

```
opto_ac5.0.port0.out-12
```

They would be numbered 12 to 23 port 1 would be the same.

20.6 Configuring I/O Ports

To change the default setting load the driver something like so:

```
loadrt opto_ac5 portconfig0=0xffff portconfig1=0xff0000
```

Of course changing the numbers to match the I/O you would like. Each port can be set up different.

Here's how to figure out the number: The configuration number represents a 32 bit long code to tell the card which I/O points are output vrs input. The lower 24 bits are the I/O points of one port. The 2 highest bits are for 2 of the on board LEDs. A one in any bit position makes the I/O point an output. The two highest bits must be output for the LEDs to work. The driver will automatically set the two highest bits for you, we won't talk about them.

The easiest way to do this is to fire up the calculator under APPLICATIONS/ACCESSORIES. Set it to scientific (click view). Set it BINARY (radio button Bin). Press 1 for every output you want and/or zero for every input. Remember that HAL pin 00 corresponds to the rightmost bit. 24 numbers represent the 24 I/O points of one port. So for the default setting (12 inputs then 12 outputs) you would push 1 twelve times (thats the outputs) then 0 twelve times (thats the inputs). Notice the first I/O point is the lowest (rightmost) bit. (that bit corresponds to HAL pin 00 .looks backwards) You should have 24 digits on the screen. Now push the Hex radio button. The displayed number (fff000) is the configport number (put a 0x in front of it designating it as a HEX number).

Another example: To set the port for 8 outputs and 16 inputs (the same as a Mesa card). Here is the 24 bits represented in a BINARY number. Bit 1 is the rightmost number.

```
000000000000000011111111
```

16 zeros for the 16 inputs and 8 ones for the 8 outputs

Which converts to FF on the calculator so 0xff is the number to use for portconfig0 and/or portconfig1 when loading the driver.

20.7 Pin Numbering

HAL pin 00 corresponds to bit 1 (the rightmost) which represents position 0 on an Opto22 relay rack. HAL pin 01 corresponds to bit 2 (one spot to the left of the rightmost) which represents position 1 on an Opto22 relay rack. HAL pin 23 corresponds to bit 24 (the leftmost) which represents position 23 on an Opto22 relay rack.

HAL pin 00 connects to pin 47 on the 50 pin connector of each port. HAL pin 01 connects to pin 45 on the 50 pin connector of each port. HAL pin 23 connects to pin 1 on the 50 pin connector of each port.

Note that Opto22 and Mesa use opposite numbering systems: Opto22 position 23 = connector pin 1, and the position goes down as the connector pin number goes up. Mesa Hostmot2 position 1 = connector pin 1, and the position number goes up as the connector pin number goes up.

Chapter 21

Pico Drivers

Pico Systems has a family of boards for doing analog servo, stepper, and PWM (digital) servo control. The boards connect to the PC through a parallel port working in EPP mode. Although most users connect one board to a parallel port, in theory any mix of up to 8 or 16 boards can be used on a single parport. One driver serves all types of boards. The final mix of I/O depends on the connected board(s). The driver doesn't distinguish between boards, it simply numbers I/O channels (encoders, etc) starting from 0 on the first board. The driver is named `hal_ppmc.ko`. The analog servo interface is also called the PPMC for Parallel Port Motion Control. There is also the Universal Stepper Controller, abbreviated the USC. And the Universal PWM Controller, or UPC.

Installing:

```
loadrt hal_ppmc port_addr=<addr1>[,<addr2>[,<addr3>...]]
```

The `port_addr` parameter tells the driver what parallel port(s) to check. By default, `<addr1>` is `0x0378`, and `<addr2>` and following are not used. The driver searches the entire address space of the enhanced parallel port(s) at `port_addr`, looking for any board(s) in the PPMC family. It then exports HAL pins for whatever it finds. During loading (or attempted loading) the driver prints some useful debugging messages to the kernel log, which can be viewed with `dmesg`.

Up to 3 parport busses may be used, and each bus may have up to 8 (or possibly 16 PPMC) devices on it.

21.1 Command Line Options

There are several options that can be specified on the `loadrt` command line. First, the USC and UPC can have an 8-bit DAC added for spindle speed control and similar functions. This can be specified with the `extradac=0xnn[,0xmm]` parameter. The part enclosed in `[]` allows you to specify this option on more than one board of the system. The first hex digit tells which EPP bus is being referred to, it corresponds to the order of the port addresses in the `port_addr` parameter, where `<addr1>` would be zero here. So, for the first EPP bus, the first USC or UPC board would be described as `0x00`, the second USC or UPC on the same bus would be `0x02`. (Note that each USC or UPC takes up two addresses, so if one is at `00`, the next would have to be `02`.)

Alternatively, the 8 digital output pins can be used as additional digital outputs, it works the same way as above with the syntax: `extradout=0xnn`. The `extradac` and `extradout` options are mutually exclusive on each board, you can only specify one.

The UPC and PPMC encoder boards can timestamp the arrival of encoder counts to refine the derivation of axis velocity. This derived velocity can be fed to the PID hal component to produce smoother D term response. The syntax is: `timestamp=0xnn[,0xmm]`, this works the same way as above to select which board is being configured. Default is to not enable the timestamp option. If you put this option on the command line, it enables the option. The first `n` selects the EPP bus, the second one matches the address of the board having the option enabled. The driver checks the revision level of the board to make sure it has firmware supporting the feature, and produces an error message if the board does not support it.

The PPMC encoder board has an option to select the encoder digital filter frequency. (The UPC has the same ability via DIP switches on the board.) Since the PPMC encoder board doesn't have these extra DIP switches, it needs to be selected via a command-line option. By default, the filter runs at 1 MHz, allowing encoders to be counted up to about 900 KHz (depending on noise and quadrature accuracy of the encoder.) The options are 1, 2.5, 5 and 10 MHz. These are set with a parameter of 1,2,5 and

10 (decimal) which is specified as the hex digit "A". These are specified in a manner similar to the above options, but with the frequency setting to the left of the bus/address digits. So, to set 5 MHz on the encoder board at address 3 on the first EPP bus, you would write : `enc_clock=0x503`

21.2 Pins

In the following pins, parameters, and functions, `<port>` is the parallel port ID. According to the naming conventions the first port should always have an ID of zero. All the boards have some method of setting the address on the EPP bus. USC and UPC have simple provisions for only two addresses, but jumper foil cuts allow up to 4 boards to be addressed. The PPMC boards have 16 possible addresses. In all cases, the driver enumerates the boards by type and exports the appropriate HAL pins. For instance, the encoders will be enumerated from zero up, in the same order as the address switches on the board specify. So, the first board will have encoders 0—3, the second board would have encoders 4—7. The first column after the bullet tells which boards will have this HAL pin or parameter associated with it. All means that this pin is available on all three board types. Option means that this pin will only be exported when that option is enabled by an optional parameter in the loadrt HAL command. These options require the board to have a sufficient revision level to support the feature.

- (All s32 output) `ppmc.<port>.encoder.<channel>.count` - Encoder position, in counts.
- (All s32 output) `ppmc.<port>.encoder.<channel>.delta` - Change in counts since last read, in raw encoder count units.
- (All float output) `'ppmc.<port>.encoder.<channel>.velocity` - Velocity scaled in user units per second. On PPMC and USC this is derived from raw encoder counts per servo period, and hence is affected by encoder granularity. On UPC boards with the 8/21/09 and later firmware, velocity estimation by timestamping encoder counts can be used to improve the smoothness of this velocity output. This can be fed to the PID HAL component to produce a more stable servo response. This function has to be enabled in the HAL command line that starts the PPMC driver, with the `timestamp=0x00` option.
- (All float output) `ppmc.<port>.encoder.<channel>.position` - Encoder position, in user units.
- (All bit bidir) `ppmc.<port>.encoder.<channel>.index-enable` - Connect to `axis.#.index-enable` for home-to-index. This is a bidirectional HAL signal. Setting it to true causes the encoder hardware to reset the count to zero on the next encoder index pulse. The driver will detect this and set the signal back to false.
- (PPMC float output) `ppmc.<port>.DAC.<channel>.value` - sends a signed value to the 16-bit Digital to Analog Converter on the PPMC DAC16 board commanding the analog output voltage of that DAC channel.
- (UPC bit input) `ppmc.<port>.pwm.<channel>.enable` - Enables a PWM generator.
- (UPC float input) `ppmc.<port>.pwm.<channel>.value` - Value which determines the duty cycle of the PWM waveforms. The value is divided by `pwm.<channel>.scale`, and if the result is 0.6 the duty cycle will be 60%, and so on. Negative values result in the duty cycle being based on the absolute value, and the direction pin is set to indicate negative.
- (USC bit input) `ppmc.<port>.stepgen.<channel>.enable` - Enables a step pulse generator.
- (USC float input) `ppmc.<port>.stepgen.<channel>.velocity` - Value which determines the step frequency. The value is multiplied by `stepgen.<channel>.scale`, and the result is the frequency in steps per second. Negative values result in the frequency being based on the absolute value, and the direction pin is set to indicate negative.
- (All bit output) `ppmc.<port>.din.<channel>.in` - State of digital input pin, see canonical digital input.
- (All bit output) `ppmc.<port>.din.<channel>.in-not` - Inverted state of digital input pin, see canonical digital input.
- (All bit input) `ppmc.<port>.dout.<channel>.out` - Value to be written to digital output, see canonical digital output.
- (Option float input) `ppmc.<port>.DAC8-<channel>.value` - Value to be written to analog output, range from 0 to 255. This sends 8 output bits to J8, which should have a Spindle DAC board connected to it. 0 corresponds to zero Volts, 255 corresponds to 10 Volts. The polarity of the output can be set for always minus, always plus, or can be controlled by the state of SSR1 (plus when on) and SSR2 (minus when on). You must specify `extradac = 0x00` on the HAL command line that loads the PPMC driver to enable this function on the first USC or UPC board.

- (Option bit input) `ppmc.<port>.dout.<channel>.out` - Value to be written to one of the 8 extra digital output pins on J8. You must specify `extradout = 0x00` on the HAL command line that loads the ppmc driver to enable this function on the first USC or UPC board. `extradac` and `extradout` are mutually exclusive features as they use the same signal lines for different purposes. These output pins will be enumerated after the standard digital outputs of the board.

21.3 Parameters

- (All float) `ppmc.<port>.encoder.<channel>.scale` - The number of counts / user unit (to convert from counts to units).
- (UPC float) `ppmc.<port>.pwm.<channel-range>.freq` - The PWM carrier frequency, in Hz. Applies to a group of four consecutive PWM generators, as indicated by `<channel-range>`. Minimum is 610Hz, maximum is 500KHz.
- (PPMC float) `ppmc.<port>.DAC.<channel>.scale` - Sets scale of DAC16 output channel such that an output value equal to the `1/scale` value will produce an output of + or - value Volts. So, if the scale parameter is 0.1 and you send a value of 0.5, the output will be 5.0 Volts.
- (UPC float) `ppmc.<port>.pwm.<channel>.scale` - Scaling for PWM generator. If `scale` is X, then the duty cycle will be 100% when the `value` pin is X (or -X).
- (UPC float) `ppmc.<port>.pwm.<channel>.max-dc` - Maximum duty cycle, from 0.0 to 1.0.
- (UPC float) `ppmc.<port>.pwm.<channel>.min-dc` - Minimum duty cycle, from 0.0 to 1.0.
- (UPC float) `ppmc.<port>.pwm.<channel>.duty-cycle` - Actual duty cycle (used mostly for troubleshooting.)
- (UPC bit) `ppmc.<port>.pwm.<channel>.bootstrap` - If true, the PWM generator will generate a short sequence of pulses of both polarities when E-stop goes false, to reset the shutdown latches on some PWM servo drives.
- (USC u32) `ppmc.<port>.stepgen.<channel-range>.setup-time` - Sets minimum time between direction change and step pulse, in units of 100ns. Applies to a group of four consecutive step generators, as indicated by `<channel-range>`. Values between 200 ns and 25.5 us can be specified.
- (USC u32) `ppmc.<port>.stepgen.<channel-range>.pulse-width` - Sets width of step pulses, in units of 100ns. Applies to a group of four consecutive step generators, as indicated by `<channel-range>`. Values between 200 ns and 25.5 us may be specified.
- (USC u32) `ppmc.<port>.stepgen.<channel-range>.pulse-space-min` - Sets minimum time between pulses, in units of 100ns. Applies to a group of four consecutive step generators, as indicated by `<channel-range>`. Values between 200 ns and 25.5 us can be specified. The maximum step rate is:
$$\frac{1}{100\text{ns} * (\text{pulsewidth} + \text{pulsespacemin})}$$
- (USC float) `ppmc.<port>.stepgen.<channel>.scale` - Scaling for step pulse generator. The step frequency in Hz is the absolute value of `velocity * scale`.
- (USC float) `ppmc.<port>.stepgen.<channel>.max-vel` - The maximum value for `velocity`. Commands greater than `max-vel` will be clamped. Also applies to negative values. (The absolute value is clamped.)
- (USC float) `ppmc.<port>.stepgen.<channel>.frequency` - Actual step pulse frequency in Hz (used mostly for troubleshooting.)
- (Option float) `ppmc.<port>.DAC8.<channel>.scale` - Sets scale of extra DAC output such that an output value equal to `scale` gives a magnitude of 10.0 V output. (The sign of the output is set by jumpers and/or other digital outputs.)
- (Option bit) `ppmc.<port>.dout.<channel>.invert` - Inverts a digital output, see canonical digital output.
- (Option bit) `ppmc.<port>.dout.<channel>.invert` - Inverts a digital output pin of J8, see canonical digital output.

21.4 Functions

- *(All funct) ppmc.<port>.read* - Reads all inputs (digital inputs and encoder counters) on one port. These reads are organized into blocks of contiguous registers to be read in a block to minimize CPU overhead.
 - *(All funct) ppmc.<port>.write* - Writes all outputs (digital outputs, steppens, PWMs) on one port. These writes are organized into blocks of contiguous registers to be written in a block to minimize CPU overhead.
-

Chapter 22

Pluto P Driver

22.1 General Info

The Pluto-P is a FPGA board featuring the ACEX1K chip from Altera.

22.1.1 Requirements

1. A Pluto-P board
2. An EPP-compatible parallel port, configured for EPP mode in the system BIOS or a PCI EPP compatible parallel port card.

Note

The Pluto P board requires EPP mode. Netmos98xx chips do not work in EPP mode. The Pluto P board will work on some computers and not on others. There is no known pattern to which computers work and which don't work.

For more information on PCI EPP compatible parallel port cards see the [LinuxCNC Supported Hardware](#) page on the wiki.

22.1.2 Connectors

- The Pluto-P board is shipped with the left connector presoldered, with the key in the indicated position. The other connectors are unpopulated. There does not seem to be a standard 12-pin IDC connector, but some of the pins of a 16P connector can hang off the board next to QA3/QZ3.
- The bottom and right connectors are on the same .1" grid, but the left connector is not. If OUT2...OUT9 are not required, a single IDC connector can span the bottom connector and the bottom two rows of the right connector.

22.1.3 Physical Pins

- Read the ACEX1K datasheet for information about input and output voltage thresholds. The pins are all configured in *LVT-TL/LVCMOS* mode and are generally compatible with 5V TTL logic.
 - Before configuration and after properly exiting LinuxCNC, all Pluto-P pins are tristated with weak pull-ups (20k-ohms min, 50k-ohms max). If the watchdog timer is enabled (the default), these pins are also tristated after an interruption of communication between LinuxCNC and the board. The watchdog timer takes approximately 6.5ms to activate. However, software bugs in the `pluto_servo` firmware or LinuxCNC can leave the Pluto-P pins in an undefined state.
 - In `pwm+dir` mode, by default `dir` is HIGH for negative values and LOW for positive values. To select HIGH for positive values and LOW for negative values, set the corresponding `dout-NN-invert` parameter TRUE to invert the signal.
-

- The index input is triggered on the rising edge. Initial testing has shown that the QZx inputs are particularly noise sensitive, due to being polled every 25ns. Digital filtering has been added to filter pulses shorter than 175ns (seven polling times). Additional external filtering on all input pins, such as a Schmitt buffer or inverter, RC filter, or differential receiver (if applicable) is recommended.
- The IN1...IN7 pins have 22-ohm series resistors to their associated FPGA pins. No other pins have any sort of protection for out-of-spec voltages or currents. It is up to the integrator to add appropriate isolation and protection. Traditional parallel port optoisolator boards do not work with pluto_servo due to the bidirectional nature of the EPP protocol.

22.1.4 LED

- When the device is unprogrammed, the LED glows faintly. When the device is programmed, the LED glows according to the duty cycle of PWM0 ($LED = UP0 \text{ xor } DOWN0$) or STEPGEN0 ($LED = STEP0 \text{ xor } DIR0$).

22.1.5 Power

- A small amount of current may be drawn from VCC. The available current depends on the unregulated DC input to the board. Alternately, regulated +3.3VDC may be supplied to the FPGA through these VCC pins. The required current is not yet known, but is probably around 50mA plus I/O current.
- The regulator on the Pluto-P board is a low-dropout type. Supplying 5V at the power jack will allow the regulator to work properly.

22.1.6 PC interface

- Only a single pluto_servo or pluto_step board is supported.

22.1.7 Rebuilding the FPGA firmware

The `src/hal/drivers/pluto_servo_firmware/` and `src/hal/drivers/pluto_step_firmware/` subdirectories contain the Verilog source code plus additional files used by Quartus for the FPGA firmwares. Altera's Quartus II software is required to rebuild the FPGA firmware. To rebuild the firmware from the .hdl and other source files, open the .qpf file and press CTRL-L. Then, recompile LinuxCNC.

Like the HAL hardware driver, the FPGA firmware is licensed under the terms of the GNU General Public License.

The gratis version of Quartus II runs only on Microsoft Windows, although there is apparently a paid version that runs on Linux.

22.1.8 For more information

Some additional information about it is available from [KNJC LLC](#) and from [the developer's blog](#).

22.2 Pluto Servo

The pluto_servo system is suitable for control of a 4-axis CNC mill with servo motors, a 3-axis mill with PWM spindle control, a lathe with spindle encoder, etc. The large number of inputs allows a full set of limit switches.

This driver features:

- 4 quadrature channels with 40MHz sample rate. The counters operate in 4x mode. The maximum useful quadrature rate is 8191 counts per LinuxCNC servo cycle, or about 8MHz for LinuxCNC's default 1ms servo rate.
- 4 PWM channels, *up/down* or *pwm+dir* style. 4095 duty cycles from -100% to +100%, including 0%. The PWM period is approximately 19.5kHz (40MHz / 2047). A PDM-like mode is also available.

- 18 digital outputs: 10 dedicated, 8 shared with PWM functions. (Example: A lathe with unidirectional PWM spindle control may use 13 total digital outputs)
- 20 digital inputs: 8 dedicated, 12 shared with Quadrature functions. (Example: A lathe with index pulse only on the spindle may use 13 total digital inputs)
- EPP communication with the PC. The EPP communication typically takes around 100 us on machines tested so far, enabling servo rates above 1kHz.

22.2.1 Pinout

- *UPx* - The *up* (up/down mode) or *pwm* (pwm+direction mode) signal from PWM generator X. May be used as a digital output if the corresponding PWM channel is unused, or the output on the channel is always negative. The corresponding digital output invert may be set to TRUE to make UPx active low rather than active high.
- *DNx* - The *down* (up/down mode) or *direction* (pwm+direction mode) signal from PWM generator X. May be used as a digital output if the corresponding PWM channel is unused, or the output on the channel is never negative. The corresponding digital output invert may be set to TRUE to make DNx active low rather than active high.
- *QAx*, *QBx* - The A and B signals for Quadrature counter X. May be used as a digital input if the corresponding quadrature channel is unused.
- *QZx* - The Z (index) signal for quadrature counter X. May be used as a digital input if the index feature of the corresponding quadrature channel is unused.
- *INx* - Dedicated digital input #x
- *OUTx* - Dedicated digital output #x
- *GND* - Ground
- *VCC* - +3.3V regulated DC

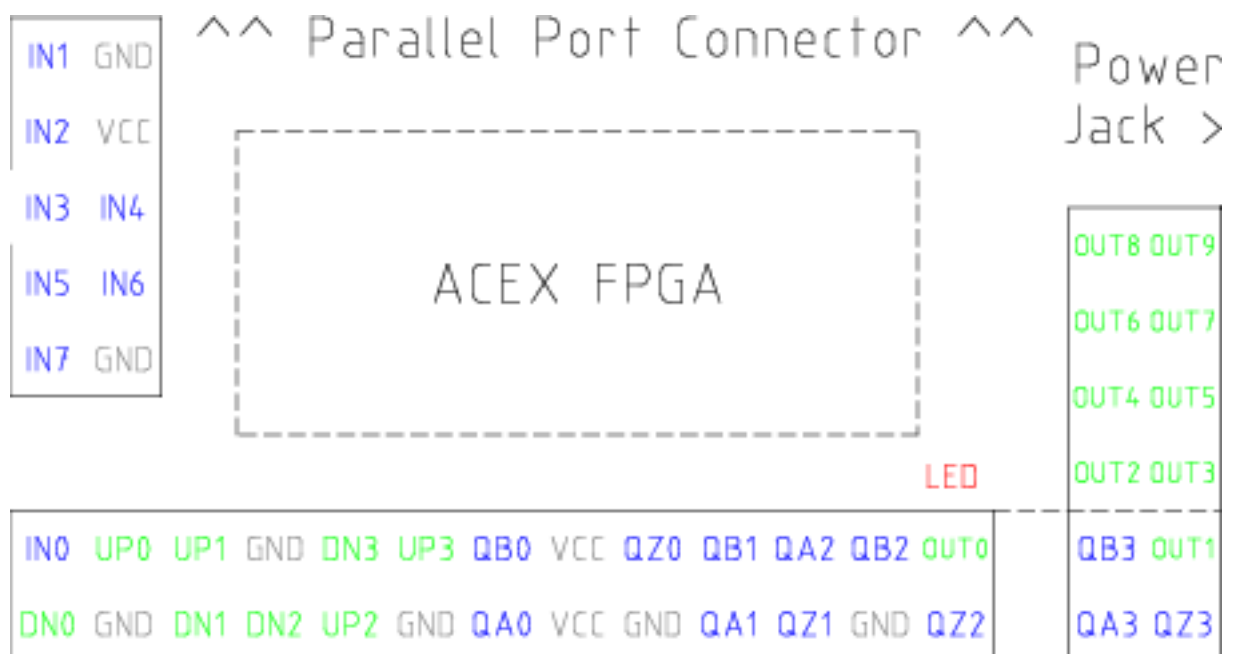

Figure 22.1: Pluto-Servo Pinout

Table 22.1: Pluto-Servo Alternate Pin Functions

Primary function	Alternate Function	Behavior if both functions used
UP0	PWM0	When pwm-0-pwmdir is TRUE, this pin is the PWM output
	OUT10	XOR'd with UP0 or PWM0
UP1	PWM1	When pwm-1-pwmdir is TRUE, this pin is the PWM output
	OUT12	XOR'd with UP1 or PWM1
UP2	PWM2	When pwm-2-pwmdir is TRUE, this pin is the PWM output
	OUT14	XOR'd with UP2 or PWM2
UP3	PWM3	When pwm-3-pwmdir is TRUE, this pin is the PWM output
	OUT16	XOR'd with UP3 or PWM3
DN0	DIR0	When pwm-0-pwmdir is TRUE, this pin is the DIR output
	OUT11	XOR'd with DN0 or DIR0
DN1	DIR1	When pwm-1-pwmdir is TRUE, this pin is the DIR output
	OUT13	XOR'd with DN1 or DIR1
DN2	DIR2	When pwm-2-pwmdir is TRUE, this pin is the DIR output
	OUT15	XOR'd with DN2 or DIR2
DN3	DIR3	When pwm-3-pwmdir is TRUE, this pin is the DIR output
	OUT17	XOR'd with DN3 or DIR3
QZ0	IN8	Read same value
QZ1	IN9	Read same value
QZ2	IN10	Read same value
QZ3	IN11	Read same value
QA0	IN12	Read same value
QA1	IN13	Read same value
QA2	IN14	Read same value
QA3	IN15	Read same value
QB0	IN16	Read same value
QB1	IN17	Read same value
QB2	IN18	Read same value
QB3	IN19	Read same value

22.2.2 Input latching and output updating

- PWM duty cycles for each channel are updated at different times.
- Digital outputs OUT0 through OUT9 are all updated at the same time. Digital outputs OUT10 through OUT17 are updated at the same time as the pwm function they are shared with.
- Digital inputs IN0 through IN19 are all latched at the same time.
- Quadrature positions for each channel are latched at different times.

22.2.3 HAL Functions, Pins and Parameters

A list of all *loadrt* arguments, HAL function names, pin names and parameter names is in the manual page, *pluto_servo.9*.

22.2.4 Compatible driver hardware

A schematic for a 2A, 2-axis PWM servo amplifier board is available from the ([the software developer](#)). The L298 H-Bridge can be used for motors up to 4A (one motor per L298) or up to 2A (two motors per L298) with the supply voltage up to 46V. However, the L298 does not have built-in current limiting, a problem for motors with high stall currents. For higher currents and voltages, some users have reported success with International Rectifier's integrated high-side/low-side drivers.

22.3 Pluto Step

Pluto-step is suitable for control of a 3- or 4-axis CNC mill with stepper motors. The large number of inputs allows for a full set of limit switches.

The board features:

- 4 *step+direction* channels with 312.5kHz maximum step rate, programmable step length, space, and direction change times
- 14 dedicated digital outputs
- 16 dedicated digital inputs
- EPP communication with the PC

22.3.1 Pinout

- *STEP_x* - The *step* (clock) output of stepgen channel *x*
- *DIR_x* - The *direction* output of stepgen channel *x*
- *IN_x* - Dedicated digital input #*x*
- *OUT_x* - Dedicated digital output #*x*
- *GND* - Ground
- *VCC* - +3.3V regulated DC

While the *extended main connector* has a superset of signals usually found on a Step & Direction DB25 connector—4 step generators, 9 inputs, and 6 general-purpose outputs—the layout on this header is different than the layout of a standard 26-pin ribbon cable to DB25 connector.

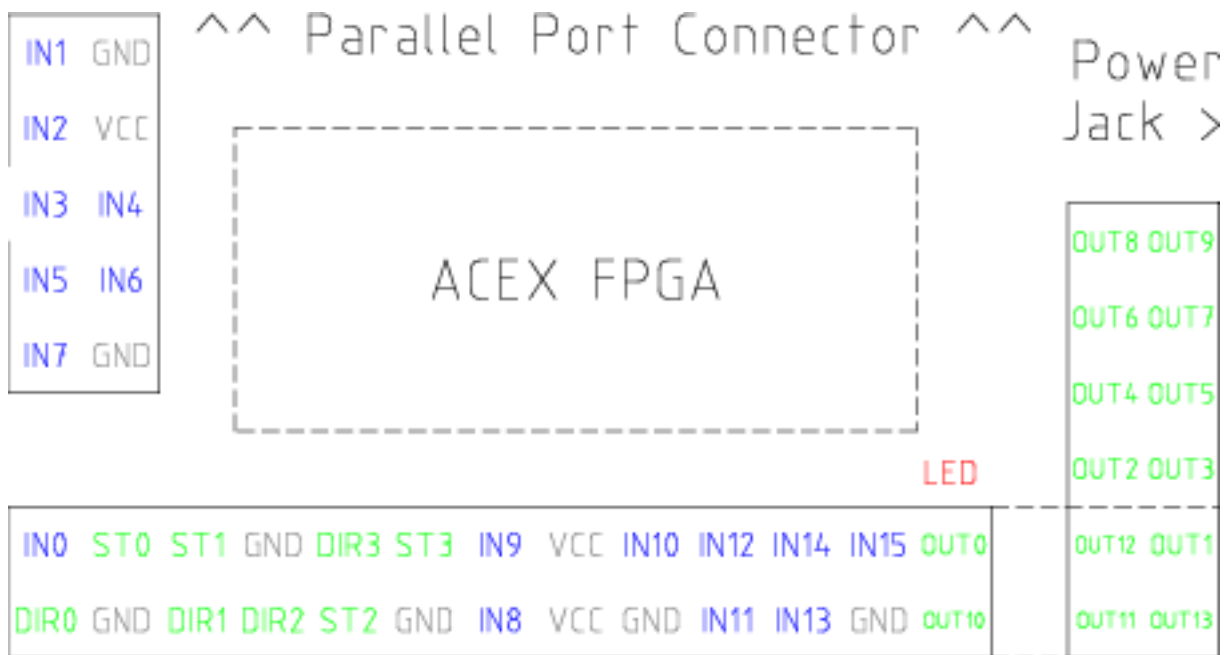

Figure 22.2: Pluto-Step Pinout

22.3.2 Input latching and output updating

- Step frequencies for each channel are updated at different times.
- Digital outputs are all updated at the same time.
- Digital inputs are all latched at the same time.
- Feedback positions for each channel are latched at different times.

22.3.3 Step Waveform Timings

The firmware and driver enforce step length, space, and direction change times. Timings are rounded up to the next multiple of $1.6\mu\text{s}$, with a maximum of $49.6\mu\text{s}$. The timings are the same as for the software stepgen component, except that *dirhold* and *dirsetup* have been merged into a single parameter *dirtime* which should be the maximum of the two, and that the same step timings are always applied to all channels.

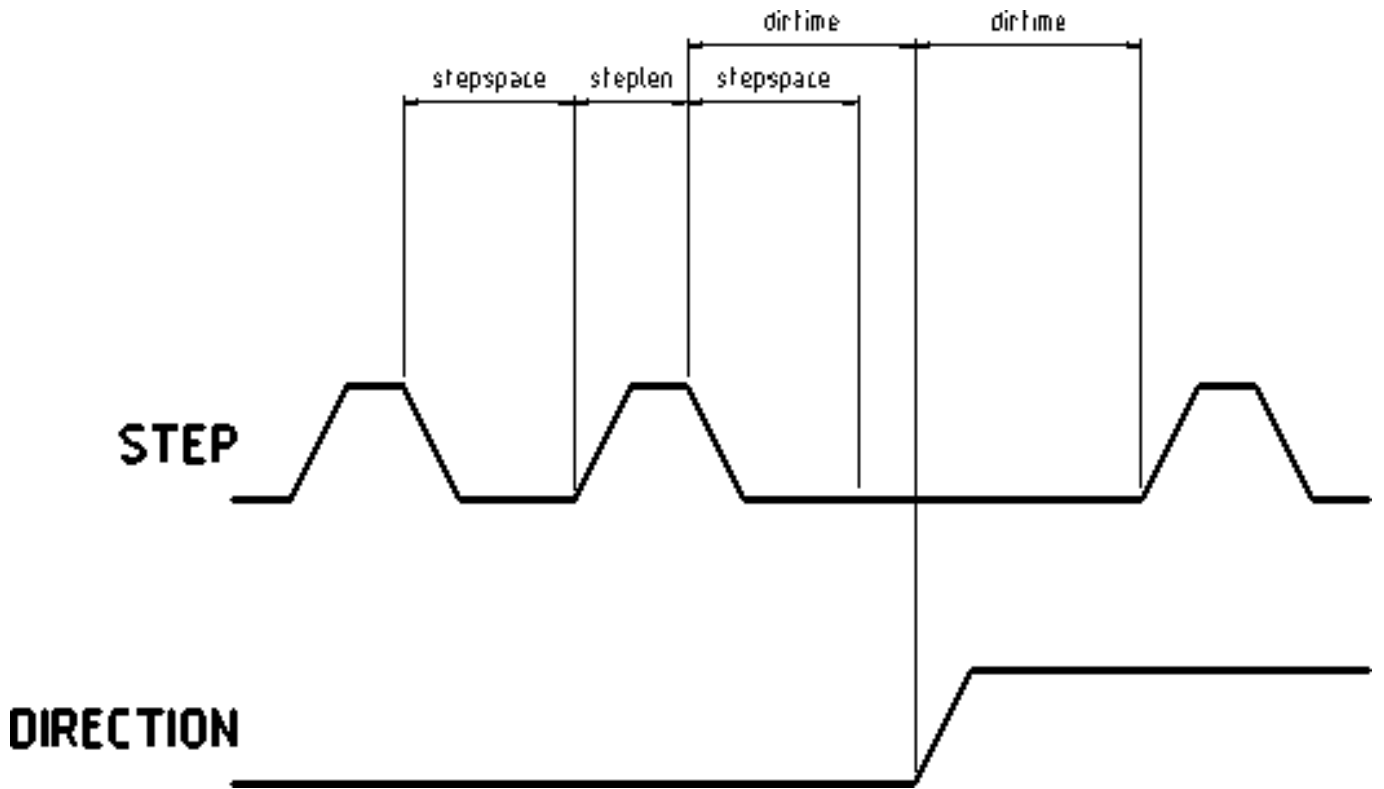

Figure 22.3: Pluto-Step Timings

22.3.4 HAL Functions, Pins and Parameters

A list of all *loadrt* arguments, HAL function names, pin names and parameter names is in the manual page, *pluto_step.9*.

Chapter 23

Servo To Go Driver

The Servo-To-Go (STG) is one of the first PC motion control cards supported by LinuxCNC. It is an ISA card and it exists in different flavors (all supported by this driver). The board includes up to 8 channels of quadrature encoder input, 8 channels of analog input and output, 32 bits digital I/O, an interval timer with interrupt and a watchdog. For more information see the [Servo To Go](#) web page.

23.1 Installing

```
loadrt hal_stg [base=<address>] [num_chan=<nr>] [dio="<dio-string>"] [model=<model>]
```

The base address field is optional; if it's not provided the driver attempts to autodetect the board. The num_chan field is used to specify the number of channels available on the card, if not used the 8 axis version is assumed. The digital inputs/outputs configuration is determined by a config string passed to insmod when loading the module. The format consists of a four character string that sets the direction of each group of pins. Each character of the direction string is either "I" or "O". The first character sets the direction of port A (Port A - DIO.0-7), the next sets port B (Port B - DIO.8-15), the next sets port C (Port C - DIO.16-23), and the fourth sets port D (Port D - DIO.24-31). The model field can be used in case the driver doesn't autodetect the right card version.

hint: after starting up the driver, *dmesh* can be consulted for messages relevant to the driver (e.g. autodetected version number and base address). For example:

```
loadrt hal_stg base=0x300 num_chan=4 dio="IOIO"
```

This example installs the STG driver for a card found at the base address of 0x300, 4 channels of encoder feedback, DACs and ADCs, along with 32 bits of I/O configured like this: the first 8 (Port A) configured as Input, the next 8 (Port B) configured as Output, the next 8 (Port C) configured as Input, and the last 8 (Port D) configured as Output

```
loadrt hal_stg
```

This example installs the driver and attempts to autodetect the board address and board model, it installs 8 axes by default along with a standard I/O setup: Port A & B configured as Input, Port C & D configured as Output.

23.2 Pins

- *stg.<channel>.counts* - (s32) Tracks the counted encoder ticks.
- *stg.<channel>.position* - (float) Outputs a converted position.
- *stg.<channel>.dac-value* - (float) Drives the voltage for the corresponding DAC.

- *stg.<channel>.adc-value* - (float) Tracks the measured voltage from the corresponding ADC.
- *stg.in-<pinnum>* - (bit) Tracks a physical input pin.
- *stg.in-<pinnum>-not* - (bit) Tracks a physical input pin, but inverted.
- *stg.out-<pinnum>* - (bit) Drives a physical output pin

For each pin, <channel> is the axis number, and <pinnum> is the logic pin number of the STG if `II00` is defined, there are 16 input pins (in-00 .. in-15) and 16 output pins (out-00 .. out-15), and they correspond to PORTs ABCD (in-00 is PORTA.0, out-15 is PORTD.7).

The in-<pinnum> HAL pin is TRUE if the physical pin is high, and FALSE if the physical pin is low. The in-<pinnum>-not HAL pin is inverted — it is FALSE if the physical pin is high. By connecting a signal to one or the other, the user can determine the state of the input.

23.3 Parameters

- *stg.<channel>.position-scale* - (float) The number of counts / user unit (to convert from counts to units).
- *stg.<channel>.dac-offset* - (float) Sets the offset for the corresponding DAC.
- *stg.<channel>.dac-gain* - (float) Sets the gain of the corresponding DAC.
- *stg.<channel>.adc-offset* - (float) Sets the offset of the corresponding ADC.
- *stg.<channel>.adc-gain* - (float) Sets the gain of the corresponding ADC.
- *stg.out-<pinnum>-invert* - (bit) Inverts an output pin.

The -invert parameter determines whether an output pin is active high or active low. If -invert is FALSE, setting the HAL out-pin TRUE drives the physical pin high, and FALSE drives it low. If -invert is TRUE, then setting the HAL out-pin TRUE will drive the physical pin low.

23.3.1 Functions

- *stg.capture-position* - Reads the encoder counters from the axis <channel>.
- *stg.write-dacs* - Writes the voltages to the DACs.
- *stg.read-adcs* - Reads the voltages from the ADCs.
- *stg.di-read* - Reads physical in- pins of all ports and updates all HAL in-<pinnum> and in-<pinnum>-not pins.
- *stg.do-write* - Reads all HAL out-<pinnum> pins and updates all physical output pins.

Chapter 24

Legal Section

24.1 Copyright Terms

Copyright (c) 2000-2013 LinuxCNC.org

Permission is granted to copy, distribute and/or modify this document under the terms of the GNU Free Documentation License, Version 1.1 or any later version published by the Free Software Foundation; with no Invariant Sections, no Front-Cover Texts, and one Back-Cover Text: "This LinuxCNC Handbook is the product of several authors writing for linuxCNC.org. As you find it to be of value in your work, we invite you to contribute to its revision and growth." A copy of the license is included in the section entitled "GNU Free Documentation License". If you do not find the license you may order a copy from Free Software Foundation, Inc. 59 Temple Place, Suite 330, Boston, MA 02111-1307

24.2 GNU Free Documentation License

GNU Free Documentation License Version 1.1, March 2000

Copyright © 2000 Free Software Foundation, Inc. 59 Temple Place, Suite 330, Boston, MA 02111-1307 USA Everyone is permitted to copy and distribute verbatim copies of this license document, but changing it is not allowed.

0. PREAMBLE

The purpose of this License is to make a manual, textbook, or other written document "free" in the sense of freedom: to assure everyone the effective freedom to copy and redistribute it, with or without modifying it, either commercially or noncommercially. Secondly, this License preserves for the author and publisher a way to get credit for their work, while not being considered responsible for modifications made by others.

This License is a kind of "copyleft", which means that derivative works of the document must themselves be free in the same sense. It complements the GNU General Public License, which is a copyleft license designed for free software.

We have designed this License in order to use it for manuals for free software, because free software needs free documentation: a free program should come with manuals providing the same freedoms that the software does. But this License is not limited to software manuals; it can be used for any textual work, regardless of subject matter or whether it is published as a printed book. We recommend this License principally for works whose purpose is instruction or reference.

1. APPLICABILITY AND DEFINITIONS

This License applies to any manual or other work that contains a notice placed by the copyright holder saying it can be distributed under the terms of this License. The "Document", below, refers to any such manual or work. Any member of the public is a licensee, and is addressed as "you".

A "Modified Version" of the Document means any work containing the Document or a portion of it, either copied verbatim, or with modifications and/or translated into another language.

A "Secondary Section" is a named appendix or a front-matter section of the Document that deals exclusively with the relationship of the publishers or authors of the Document to the Document's overall subject (or to related matters) and contains nothing that

could fall directly within that overall subject. (For example, if the Document is in part a textbook of mathematics, a Secondary Section may not explain any mathematics.) The relationship could be a matter of historical connection with the subject or with related matters, or of legal, commercial, philosophical, ethical or political position regarding them.

The "Invariant Sections" are certain Secondary Sections whose titles are designated, as being those of Invariant Sections, in the notice that says that the Document is released under this License.

The "Cover Texts" are certain short passages of text that are listed, as Front-Cover Texts or Back-Cover Texts, in the notice that says that the Document is released under this License.

A "Transparent" copy of the Document means a machine-readable copy, represented in a format whose specification is available to the general public, whose contents can be viewed and edited directly and straightforwardly with generic text editors or (for images composed of pixels) generic paint programs or (for drawings) some widely available drawing editor, and that is suitable for input to text formatters or for automatic translation to a variety of formats suitable for input to text formatters. A copy made in an otherwise Transparent file format whose markup has been designed to thwart or discourage subsequent modification by readers is not Transparent. A copy that is not "Transparent" is called "Opaque".

Examples of suitable formats for Transparent copies include plain ASCII without markup, Texinfo input format, LaTeX input format, SGML or XML using a publicly available DTD, and standard-conforming simple HTML designed for human modification. Opaque formats include PostScript, PDF, proprietary formats that can be read and edited only by proprietary word processors, SGML or XML for which the DTD and/or processing tools are not generally available, and the machine-generated HTML produced by some word processors for output purposes only.

The "Title Page" means, for a printed book, the title page itself, plus such following pages as are needed to hold, legibly, the material this License requires to appear in the title page. For works in formats which do not have any title page as such, "Title Page" means the text near the most prominent appearance of the work's title, preceding the beginning of the body of the text.

2. VERBATIM COPYING

You may copy and distribute the Document in any medium, either commercially or noncommercially, provided that this License, the copyright notices, and the license notice saying this License applies to the Document are reproduced in all copies, and that you add no other conditions whatsoever to those of this License. You may not use technical measures to obstruct or control the reading or further copying of the copies you make or distribute. However, you may accept compensation in exchange for copies. If you distribute a large enough number of copies you must also follow the conditions in section 3.

You may also lend copies, under the same conditions stated above, and you may publicly display copies.

3. COPYING IN QUANTITY

If you publish printed copies of the Document numbering more than 100, and the Document's license notice requires Cover Texts, you must enclose the copies in covers that carry, clearly and legibly, all these Cover Texts: Front-Cover Texts on the front cover, and Back-Cover Texts on the back cover. Both covers must also clearly and legibly identify you as the publisher of these copies. The front cover must present the full title with all words of the title equally prominent and visible. You may add other material on the covers in addition. Copying with changes limited to the covers, as long as they preserve the title of the Document and satisfy these conditions, can be treated as verbatim copying in other respects.

If the required texts for either cover are too voluminous to fit legibly, you should put the first ones listed (as many as fit reasonably) on the actual cover, and continue the rest onto adjacent pages.

If you publish or distribute Opaque copies of the Document numbering more than 100, you must either include a machine-readable Transparent copy along with each Opaque copy, or state in or with each Opaque copy a publicly-accessible computer-network location containing a complete Transparent copy of the Document, free of added material, which the general network-using public has access to download anonymously at no charge using public-standard network protocols. If you use the latter option, you must take reasonably prudent steps, when you begin distribution of Opaque copies in quantity, to ensure that this Transparent copy will remain thus accessible at the stated location until at least one year after the last time you distribute an Opaque copy (directly or through your agents or retailers) of that edition to the public.

It is requested, but not required, that you contact the authors of the Document well before redistributing any large number of copies, to give them a chance to provide you with an updated version of the Document.

4. MODIFICATIONS

You may copy and distribute a Modified Version of the Document under the conditions of sections 2 and 3 above, provided that you release the Modified Version under precisely this License, with the Modified Version filling the role of the Document, thus licensing distribution and modification of the Modified Version to whoever possesses a copy of it. In addition, you must do these things in the Modified Version:

- A. Use in the Title Page (and on the covers, if any) a title distinct from that of the Document, and from those of previous versions (which should, if there were any, be listed in the History section of the Document). You may use the same title as a previous version if the original publisher of that version gives permission. B. List on the Title Page, as authors, one or more persons or entities responsible for authorship of the modifications in the Modified Version, together with at least five of the principal authors of the Document (all of its principal authors, if it has less than five). C. State on the Title page the name of the publisher of the Modified Version, as the publisher. D. Preserve all the copyright notices of the Document. E. Add an appropriate copyright notice for your modifications adjacent to the other copyright notices. F. Include, immediately after the copyright notices, a license notice giving the public permission to use the Modified Version under the terms of this License, in the form shown in the Addendum below. G. Preserve in that license notice the full lists of Invariant Sections and required Cover Texts given in the Document's license notice. H. Include an unaltered copy of this License. I. Preserve the section entitled "History", and its title, and add to it an item stating at least the title, year, new authors, and publisher of the Modified Version as given on the Title Page. If there is no section entitled "History" in the Document, create one stating the title, year, authors, and publisher of the Document as given on its Title Page, then add an item describing the Modified Version as stated in the previous sentence. J. Preserve the network location, if any, given in the Document for public access to a Transparent copy of the Document, and likewise the network locations given in the Document for previous versions it was based on. These may be placed in the "History" section. You may omit a network location for a work that was published at least four years before the Document itself, or if the original publisher of the version it refers to gives permission. K. In any section entitled "Acknowledgements" or "Dedications", preserve the section's title, and preserve in the section all the substance and tone of each of the contributor acknowledgements and/or dedications given therein. L. Preserve all the Invariant Sections of the Document, unaltered in their text and in their titles. Section numbers or the equivalent are not considered part of the section titles. M. Delete any section entitled "Endorsements". Such a section may not be included in the Modified Version. N. Do not retitle any existing section as "Endorsements" or to conflict in title with any Invariant Section.

If the Modified Version includes new front-matter sections or appendices that qualify as Secondary Sections and contain no material copied from the Document, you may at your option designate some or all of these sections as invariant. To do this, add their titles to the list of Invariant Sections in the Modified Version's license notice. These titles must be distinct from any other section titles.

You may add a section entitled "Endorsements", provided it contains nothing but endorsements of your Modified Version by various parties—for example, statements of peer review or that the text has been approved by an organization as the authoritative definition of a standard.

You may add a passage of up to five words as a Front-Cover Text, and a passage of up to 25 words as a Back-Cover Text, to the end of the list of Cover Texts in the Modified Version. Only one passage of Front-Cover Text and one of Back-Cover Text may be added by (or through arrangements made by) any one entity. If the Document already includes a cover text for the same cover, previously added by you or by arrangement made by the same entity you are acting on behalf of, you may not add another; but you may replace the old one, on explicit permission from the previous publisher that added the old one.

The author(s) and publisher(s) of the Document do not by this License give permission to use their names for publicity for or to assert or imply endorsement of any Modified Version.

5. COMBINING DOCUMENTS

You may combine the Document with other documents released under this License, under the terms defined in section 4 above for modified versions, provided that you include in the combination all of the Invariant Sections of all of the original documents, unmodified, and list them all as Invariant Sections of your combined work in its license notice.

The combined work need only contain one copy of this License, and multiple identical Invariant Sections may be replaced with a single copy. If there are multiple Invariant Sections with the same name but different contents, make the title of each such section unique by adding at the end of it, in parentheses, the name of the original author or publisher of that section if known, or else a unique number. Make the same adjustment to the section titles in the list of Invariant Sections in the license notice of the combined work.

In the combination, you must combine any sections entitled "History" in the various original documents, forming one section entitled "History"; likewise combine any sections entitled "Acknowledgements", and any sections entitled "Dedications". You must delete all sections entitled "Endorsements."

6. COLLECTIONS OF DOCUMENTS

You may make a collection consisting of the Document and other documents released under this License, and replace the individual copies of this License in the various documents with a single copy that is included in the collection, provided that you follow the rules of this License for verbatim copying of each of the documents in all other respects.

You may extract a single document from such a collection, and distribute it individually under this License, provided you insert a copy of this License into the extracted document, and follow this License in all other respects regarding verbatim copying of that document.

7. AGGREGATION WITH INDEPENDENT WORKS

A compilation of the Document or its derivatives with other separate and independent documents or works, in or on a volume of a storage or distribution medium, does not as a whole count as a Modified Version of the Document, provided no compilation copyright is claimed for the compilation. Such a compilation is called an "aggregate", and this License does not apply to the other self-contained works thus compiled with the Document, on account of their being thus compiled, if they are not themselves derivative works of the Document.

If the Cover Text requirement of section 3 is applicable to these copies of the Document, then if the Document is less than one quarter of the entire aggregate, the Document's Cover Texts may be placed on covers that surround only the Document within the aggregate. Otherwise they must appear on covers around the whole aggregate.

8. TRANSLATION

Translation is considered a kind of modification, so you may distribute translations of the Document under the terms of section 4. Replacing Invariant Sections with translations requires special permission from their copyright holders, but you may include translations of some or all Invariant Sections in addition to the original versions of these Invariant Sections. You may include a translation of this License provided that you also include the original English version of this License. In case of a disagreement between the translation and the original English version of this License, the original English version will prevail.

9. TERMINATION

You may not copy, modify, sublicense, or distribute the Document except as expressly provided for under this License. Any other attempt to copy, modify, sublicense or distribute the Document is void, and will automatically terminate your rights under this License. However, parties who have received copies, or rights, from you under this License will not have their licenses terminated so long as such parties remain in full compliance.

10. FUTURE REVISIONS OF THIS LICENSE

The Free Software Foundation may publish new, revised versions of the GNU Free Documentation License from time to time. Such new versions will be similar in spirit to the present version, but may differ in detail to address new problems or concerns. See <http://www.gnu.org/copyleft/>.

Each version of the License is given a distinguishing version number. If the Document specifies that a particular numbered version of this License "or any later version" applies to it, you have the option of following the terms and conditions either of that specified version or of any later version that has been published (not as a draft) by the Free Software Foundation. If the Document does not specify a version number of this License, you may choose any version ever published (not as a draft) by the Free Software Foundation.

ADDENDUM: How to use this License for your documents

To use this License in a document you have written, include a copy of the License in the document and put the following copyright and license notices just after the title page:

Copyright (c) YEAR YOUR NAME. Permission is granted to copy, distribute and/or modify this document under the terms of the GNU Free Documentation License, Version 1.1 or any later version published by the Free Software Foundation; with the Invariant Sections being LIST THEIR TITLES, with the Front-Cover Texts being LIST, and with the Back-Cover Texts being LIST. A copy of the license is included in the section entitled "GNU Free Documentation License".

If you have no Invariant Sections, write "with no Invariant Sections" instead of saying which ones are invariant. If you have no Front-Cover Texts, write "no Front-Cover Texts" instead of "Front-Cover Texts being LIST"; likewise for Back-Cover Texts.

If your document contains nontrivial examples of program code, we recommend releasing these examples in parallel under your choice of free software license, such as the GNU General Public License, to permit their use in free software.

Chapter 25

Index

–
7i65, [60](#)

A

abs, [58](#)
ACEX1K, [139](#)
addf, [40](#)
and2, [57](#)
at_pid, [61](#)
AX5214H Driver, [114](#)
axis, [57](#)

B

Basic HAL Tutorial, [39](#)
biquad, [59](#)
Bit, [44](#)
bldc_hall3, [61](#)
blend, [58](#)
blocks, [6](#)

C

charge_pump, [62](#)
clarke2, [61](#)
clarke3, [61](#)
clarkeinv, [61](#)
ClassicLadder, [5](#)
classicladder, [57](#)
CNC, [2](#)
comp, [58](#)
Comp HAL Component Generator, [100](#)
Compiling realtime components outside the source tree, [106](#)
constant, [58](#)
conv_bit_s32, [59](#)
conv_bit_u32, [59](#)
conv_float_s32, [59](#)
conv_float_u32, [60](#)
conv_s32_bit, [60](#)
conv_s32_float, [60](#)
conv_s32_u32, [60](#)
conv_u32_bit, [60](#)
conv_u32_float, [60](#)
conv_u32_s32, [60](#)
counter, [58](#)

D

ddt, [58](#)
deadzone, [58](#)
debounce, [58, 80](#)

E

edge, [58](#)
encoder, [5, 61, 74](#)
Encoder Block Diagram, [74](#)
encoder_ratio, [62](#)
estop_latch, [62](#)

F

feedcomp, [62](#)
Five Phase, [71](#)
flipflop, [58](#)
Float, [44](#)
Four Phase, [70](#)
freqgen, [61](#)

G

gantrykins, [60](#)
gearchange, [62](#)
genhexkins, [60](#)
genserkins, [61](#)
gladevcp, [57](#)
GS2 VFD Driver, [116](#)

H

HAL, [2](#)
HAL Component, [4](#)
HAL Components, [56](#)
HAL Introduction, [2](#)
HAL Parameter, [4](#)
HAL Physical-Pin, [4](#)
HAL Pin, [4](#)
HAL Signal, [4](#)
HAL Tools, [37](#)
HAL Tutorial, [8](#)
HAL Type, [4](#)
HAL User Interface, [92](#)
hal-ax5214h, [6](#)
hal-m5i20, [6](#)
hal-motenc, [6](#)

hal-parport, 6
hal-ppmc, 6
hal-stg, 6
hal-vti, 6
halcmd, 6
Halmeter
 Tutorial-Halmeter, 13

halmeter, 6, 37
halscope, 6
Halshow, 49
halui, 5
Hardware Drivers, 6
hm2_7i43, 60
hm2_pci, 60
hostmot2, 60
hypot, 58

I

ilowpass, 62
integ, 59
invert, 59
iocontrol, 5

J

joyhandle, 62

K

kins, 60
knob2float, 62

L

limit1, 59
limit2, 59
limit3, 59
loadrt, 40
loadusr, 41
logic, 58
lowpass, 59
lut5, 58, 81

M

maj3, 59
match8, 58
maxkins, 61
MDI, 95
Mesa HostMot2 Driver, 118
minmax, 62
Motenc Driver, 130
motion, 5, 57
mult2, 58
mux16, 58
mux2, 59
mux4, 59
mux8, 59

N

near, 59
net, 41

not, 57

O

offset, 59
oneshot, 58
Opto22 Driver, 132
or2, 57

P

Parallel Port Driver, 83
parport functions, 85
Pico PPMC Driver, 135
pid, 5, 61, 77
PID Block Diagram, 77
Pluto P Driver, 139
pluto-servo, 140
pluto-servo alternate pin functions, 142
pluto-servo pinout, 141
pluto-step, 143
pluto-step pinout, 144
pluto-step timings, 145
pluto_servo, 60
pluto_step, 60
pumakins, 61
pwmgen, 61, 73

R

Realtime Components, 66
rotatekins, 61

S

s32, 44
sample_hold, 62
sampler, 62
scale, 59
scarakins, 61
select8, 58
serport, 60
Servo To Go Driver, 146
setp, 42
sets, 43
siggen, 5, 62, 80
sim-encoder, 79
sim_encoder, 62
sphereprobe, 62
stepgen, 5, 15, 61, 66
Stepgen Block Diagram, 66, 68
steptest, 62
streamer, 62
sum2, 58
supply, 6, 62

T

threads, 57
threadtest, 62
time, 45, 63
timedelay, 63
timedelta, 63

tmax, [45](#)
toggle, [63](#)
toggle2nist, [63](#)
torch height control, [60](#)
tripodkins, [61](#)
tristate_bit, [63](#)
tristate_float, [63](#)
trivkins, [61](#)
Tutorial-Halimeter, [13](#)
Two and Three Phase, [70](#)

U

u32, [44](#)
updown, [58](#)

W

watchdog, [63](#)
wcomp, [59](#)
weighted_sum, [59](#)

X

xor2, [57](#)
